

SONY®

3-074-253-11(1)

CD/DVD Player

Operating Instructions



DVP-NC655P

© 2002 Sony Corporation

WARNING

To prevent fire or shock hazard, do not expose the unit to rain or moisture. To avoid electrical shock, do not open the cabinet. Refer servicing to qualified personnel only.

CAUTION

The use of optical instruments with this product will increase eye hazard. As the laser beam used in this CD/DVD player is harmful to eyes, do not attempt to disassemble the cabinet.

Refer servicing to qualified personnel only.

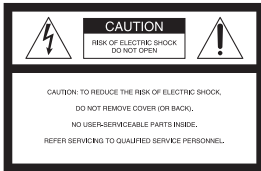

This symbol is intended to alert the user to the presence of uninsulated "dangerous voltage" within the product's enclosure that may be of sufficient magnitude to constitute a risk of electric shock to persons.



This symbol is intended to alert the user to the presence of important operating and maintenance (servicing) instructions in the literature accompanying the appliance.

The following caution label is located on the laser protective housing inside the enclosure.



Owner's Record

The model and serial numbers are located at the rear of the unit. Record the serial number in the space provided below. Refer to them whenever you call upon your Sony dealer regarding this product.

Model No. DVP-NC655P
Serial No. _____

CAUTION

You are cautioned that any change or modifications not expressly approved in this manual could void your authority to operate this equipment.

Note

This equipment has been tested and found to comply with the limits for a Class B digital device, pursuant to Part 15 of the FCC Rules. These limits are designed to provide reasonable protection against harmful interference in a residential installation. This equipment generates, uses, and can radiate radio frequency energy and, if not installed and used in accordance with the instructions, may cause harmful interference to radio communications. However, there is no guarantee that interference will not occur in a particular installation. If this equipment does cause harmful interference to radio or television reception, which can be determined by turning the equipment off and on, the user is encouraged to try to correct the interference by one or more of the following measures:

- Reorient or relocate the receiving antenna.
- Increase the separation between the equipment and receiver.
- Connect the equipment into an outlet on a circuit different from that to which the receiver is connected.
- Consult the dealer or an experienced radio/TV technician for help.

Welcome!

Thank you for purchasing this Sony CD/DVD Player. Before operating this player, please read this manual thoroughly and retain it for future reference.

Precautions

On safety

- Caution – The use of optical instruments with this product will increase eye hazard.
- To prevent fire or shock hazard, do not place objects filled with liquids, such as vases, on the apparatus.
- Should any solid object or liquid fall into the cabinet, unplug the player and have it checked by qualified personnel before operating it any further.

On power sources

- The player is not disconnected from the AC power source as long as it is connected to the wall outlet, even if the player itself has been turned off.
- If you are not going to use the player for a long time, be sure to disconnect the player from the wall outlet. To disconnect the AC power cord, grasp the plug itself; never pull the cord.

On placement

- Place the player in a location with adequate ventilation to prevent heat build-up in the player.
- Do not place the player on a soft surface such as a rug that might block the ventilation holes.
- Do not place the player in a location near heat sources, or in a place subject to direct sunlight, excessive dust, or mechanical shock.
- Do not install the player in an inclined position. It is designed to be operated in a horizontal position only.
- Keep the player and discs away from equipment with strong magnets, such as microwave ovens, or large loudspeakers.

On operation

- If the player is brought directly from a cold to a warm location, or is placed in a very damp room, moisture may condense on the lenses inside the player. Should this occur, the player may not operate properly. In this case, remove the disc and leave the player turned on for about half an hour until the moisture evaporates.

- When you move the player, take out any discs. If you don't, the disc may be damaged.

On adjusting volume

Do not turn up the volume while listening to a section with very low level inputs or no audio signals. If you do, the speakers may be damaged when a peak level section is played.

On cleaning

Clean the cabinet, panel, and controls with a soft cloth slightly moistened with a mild detergent solution. Do not use any type of abrasive pad, scouring powder or solvent such as alcohol or benzene.

On cleaning discs

Do not use a commercially available cleaning disc. It may cause a malfunction.

IMPORTANT NOTICE

Caution: This player is capable of holding a still video image or on-screen display image on your television screen indefinitely. If you leave the still video image or on-screen display image displayed on your TV for an extended period of time you risk permanent damage to your television screen. Projection televisions are especially susceptible to this.

On transporting the player

Before transporting the player, follow the procedure below to return the internal mechanisms to their original positions.

- 1 Remove all the discs from the disc tray.
- 2 Press ▲ to close the disc tray. Make sure that "NO DISC" appears on the front panel display.
- 3 Press I/⏻ to turn off the player. The player enters standby mode and the power indicator lights up in red.
- 4 Disconnect the AC power cord.

If you have any questions or problems concerning your player, please consult your nearest Sony dealer.

Table of Contents

WARNING	2
Welcome!	2
Precautions	3
About this Manual	6
This Player Can Play the Following Discs	6
Notes about the Discs	7
Index to Parts and Controls	8
Guide to the Control Menu Display	12
<hr/>	
Simple Start Guide	15
Quick Overview	15
Step 1: Unpacking	15
Step 2: Inserting Batteries into the Remote	15
Step 3: TV Hookups	16
Step 4: Playing a Disc	17
<hr/>	
Hookups	18
Hooking Up the Player	18
Step 1: Connecting the Video Cords	18
Step 2: Connecting the Audio Cords	20
Step 3: Connecting the Power Cord	25
Step 4: Quick Setup	25
<hr/>	
Playing Discs	28
Playing Discs	28
Searching for a Particular Point on a Disc (Scan, Slow-motion Play, Search, Freeze Frame)	31
Resuming Playback from the Point Where You Stopped the Disc (Resume Play/Multi-disc Resume)	32
Using the DVD's Menu	33
Selecting "ORIGINAL" or "PLAY LIST" on a DVD-RW Disc	33
Playing VIDEO CDs with PBC Functions (PBC Playback)	34
Playing an MP3 Audio Track	35
Various Play Mode Functions (Program Play, Shuffle Play, Repeat Play, A-B Repeat Play)	38
<hr/>	
Searching for a Scene	44
Searching for a Title/Chapter/Track/Index/Scene (Search mode)	44
Searching by Scene (PICTURE NAVIGATION)	45
<hr/>	
Viewing Information About the Disc	47
Checking the Playing Time and Remaining Time	47
Checking the Play Information	49
<hr/>	
Sound Adjustments	51
Changing the Sound	51
TV Virtual Surround Settings (TVS)	52

Enjoying Movies	54
Changing the Angles	54
Displaying the Subtitles	55
Adjusting the Picture Quality (BNR)	56
Adjusting the Playback Picture (CUSTOM PICTURE MODE)	57
Enhancing the Playback Picture (DIGITAL VIDEO ENHANCER)	58





Using Various Additional Functions	60
Locking Discs (CUSTOM PARENTAL CONTROL, PARENTAL CONTROL)	60
Operation Sound Effects (Sound Feedback)	64
Controlling Your TV or AV Amplifier (Receiver) with the Supplied Remote	65

Settings and Adjustments	67
Using the Setup Display	67
Setting the Display or Sound Track Language (LANGUAGE SETUP)	68
Settings for the Display (SCREEN SETUP)	69
Custom Settings (CUSTOM SETUP)	71
Settings for the Sound (AUDIO SETUP)	72

Additional Information	75
Troubleshooting	75
Self-diagnosis Function (When letters/numbers appear in the display)	77
Glossary	78
Specifications	80
Language Code List	81
Index	82





About this Manual

- Instructions in this manual describe the controls on the remote. You can also use the controls on the player if they have the same or similar names as those on the remote.
- “DVD” may be used as a general term for DVD VIDEOS, DVD-Rs, and DVD-RWs.
- The meaning of the icons used in this manual is described below:

Icon	Meaning
	Functions available for DVD VIDEOS or DVD-Rs/DVD-RWs in video mode
	Functions available for DVD-RWs in VR (Video Recording) mode
	Functions available for VIDEO CDs or CD-Rs/CD-RWs in video CD format
	Functions available for DATA CDs (CD-ROMs/CD-Rs/CD-RWs containing MP3* audio tracks)
	Functions available for music CDs or CD-Rs/CD-RWs in music CD format

* MP3 (MPEG1 Audio Layer 3) is a standard format defined by ISO (International Standard Organization)/MPEG which compresses audio data.

This Player Can Play the Following Discs

Format of discs	
DVD VIDEO (page 78)	
DVD-RW (page 78)	
VIDEO CD	
Music CD	

“DVD VIDEO” and “DVD-RW” are trademarks.

Region code

Your player has a region code printed on the back of the unit and only will play DVD VIDEO discs (playback only) labeled with identical region codes. This system is used to protect copyrights.

DVD VIDEOS labeled  will also play on this player.

If you try to play any other DVD VIDEO, the message “Playback prohibited by area limitations.” will appear on the TV screen. Depending on the DVD VIDEO, no region code indication may be labeled even though playing the DVD VIDEO is prohibited by area restrictions.



Example of discs that the player cannot play

The player cannot play the following discs:

- All CD-ROMs (including PHOTO CDs)/CD-Rs/CD-RWs other than those recorded in the following formats:
 - music CD format
 - video CD format
 - MP3 format that conforms to ISO9660* Level 1/Level 2, or its extended format, Joliet
 - Data part of CD-Extras
 - DVD-ROMs
 - DVD Audio discs
 - HD layer on Super Audio CDs
- * A logical format of files and folders on CD-ROMs defined by ISO (International Standard Organization).

Also, the player cannot play the following discs:

- A DVD VIDEO with a different region code.
- A disc recorded in a color system other than NTSC, such as PAL or SECAM (this player conforms to the NTSC color system).
- A disc that has a non-standard shape (e.g., card, heart).
- A disc with paper or stickers on it.
- A disc that has the adhesive of cellophane tape or a sticker still left on it.

Note

Some DVD-Rs, DVD-RWs, CD-Rs, or CD-RWs cannot be played on this player due to the recording quality or physical condition of the disc, or the characteristics of the recording device. Also, images in DVD-RW discs with CPRM* protection may not be played if they contain a copy protection signal. "Copyright lock" appears on the screen. For more information, see the operating instructions for the recording device.

Note that discs created in the Packet Write format cannot be played.

* CPRM (Content Protection for Recordable Media) is a coding technology that protects copyright for images.

Note on playback operations of DVDs and VIDEO CDs

Some playback operations of DVDs and VIDEO CDs may be intentionally set by

software producers. Since this player plays DVDs and VIDEO CDs according to the disc contents the software producers designed, some playback features may not be available. Also, refer to the instructions supplied with the DVDs or VIDEO CDs.

Copyrights

This product incorporates copyright protection technology that is protected by method claims of certain U.S. patents, other intellectual property rights owned by Macrovision Corporation, and other rights owners. Use of this copyright protection technology must be authorized by Macrovision Corporation, and is intended for home and other limited viewing uses only unless otherwise authorized by Macrovision Corporation. Reverse engineering or disassembly is prohibited.

Notes about the Discs

- To keep the disc clean, handle the disc by its edge. Do not touch the surface.



- Do not expose the disc to direct sunlight or heat sources such as hot air ducts, or leave it in a car parked in direct sunlight as the temperature may rise considerably inside the car.
- After playing, store the disc in its case.
- Clean the disc with a cleaning cloth. Wipe the disc from the center out.



- Do not use solvents such as benzene, thinner, commercially available cleaners, or anti-static spray intended for vinyl LPs.

Index to Parts and Controls

For more information, refer to the pages indicated in parentheses.

Front panel

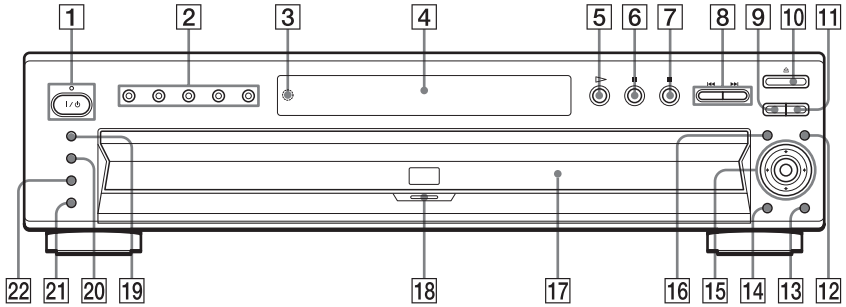

- 1** (on/standby) button/indicator (28)
Lights up in green when the power is on and lights up in red when the player is in standby mode.
- 2** DISC SELECT 1 – 5 buttons/indicators (29)
The number lights up in amber when there is a disc. When a disc is selected, the indicator lights up in green.
- 3** (remote sensor) (15)
- 4** Front panel display (9)
- 5** (playback) button (28)
The button has a tactile dot.*
- 6** (pause) button (29)
- 7** (stop) button (29)
- 8** (previous/next) buttons (29)
- 9** EXCHANGE button (30)

- 10** (open/close) button (28)
- 11** DISC SKIP button (28)
- 12** MENU button (35)
- 13** RETURN button (30)
- 14** DISPLAY button (12)
- 15** (directional/enter) buttons (33)
- 16** TOP MENU button (33)
- 17** Disc tray (28)
- 18** PROGRESSIVE indicator (69)
- 19** PICTURE MODE button (57)
- 20** SURROUND button (52)
- 21** ONE/ALL button (38)
- 22** LOAD button (29)

* Use the tactile dot as a reference when operating the player.

Front panel display

When playing back a DVD VIDEO/DVD-RW

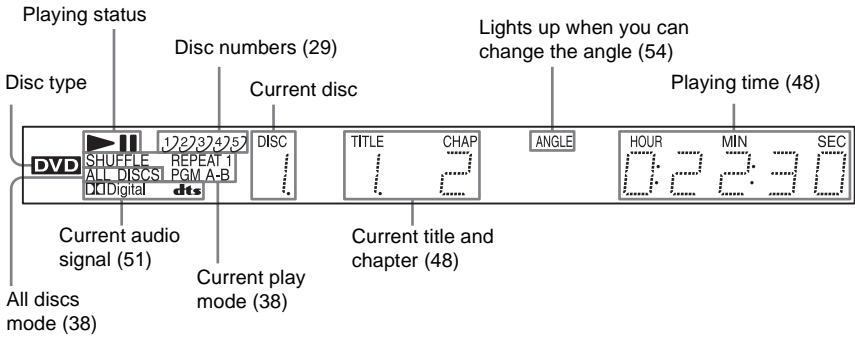

When playing back a VIDEO CD with Playback Control (PBC) (34)

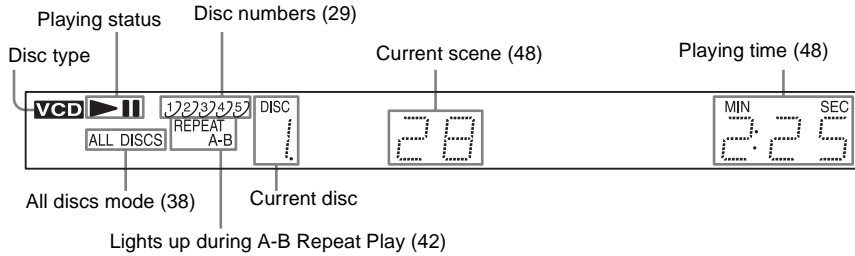

When playing back a CD, DATA CD (MP3 audio), or VIDEO CD (without PBC)

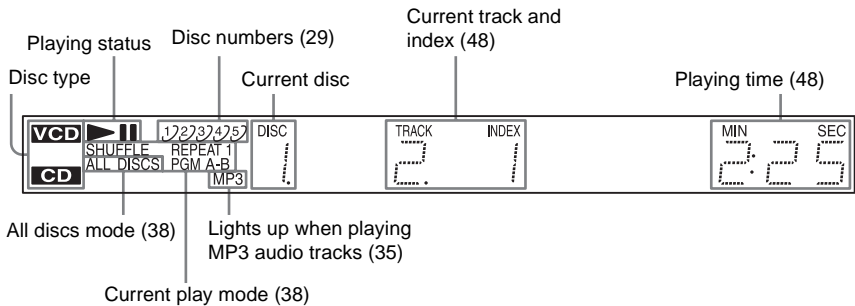

Rear panel

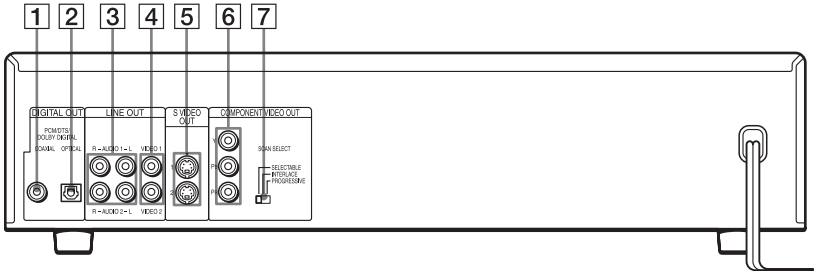

- 1** DIGITAL OUT (COAXIAL) jack (22) (23) (24)
- 2** DIGITAL OUT (OPTICAL) jack (22) (23) (24)
- 3** LINE OUT L/R (AUDIO) 1/2 jacks (21) (22) (23)
- 4** LINE OUT (VIDEO) 1/2 jacks (18)
- 5** S VIDEO OUT 1/2 jacks (18)
- 6** COMPONENT VIDEO OUT (Y, Pb, Pr) jacks (18)
- 7** COMPONENT VIDEO OUT/SCAN SELECT switch (69)

Remote

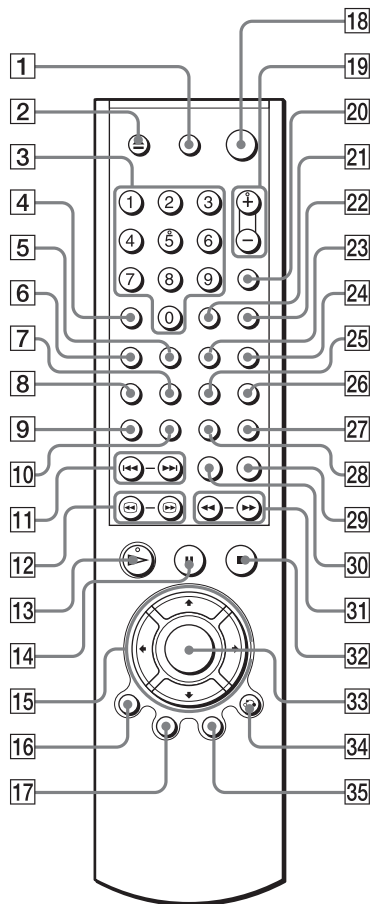

- 1** TV \mathbb{I}/\mathbb{O} (on/standby) button (65)
- 2** \blacktriangle OPEN/CLOSE button (28)
- 3** Number buttons (33)
The number 5 button has a tactile dot.*
- 4** CLEAR button (38)
- 5** ONE/ALL DISCS button (38)
- 6** SHUFFLE button (40)
- 7** SUBTITLE button (55)
- 8** AUDIO button (51)
- 9** TIME/TEXT button (47)
- 10** REPEAT button (41)
- 11** $\blacktriangleleft/\blacktriangleright$ PREV (previous) /NEXT buttons (29)
- 12** $\blacktriangleleft\|\blacktriangleright$ SEARCH/STEP buttons (31)
- 13** \blacktriangleright PLAY button (28)
The \blacktriangleright button has a tactile dot.*
- 14** $\|\|\|$ PAUSE button (29)
- 15** $\blacktriangleleft/\blacktriangleup/\blacktriangledown/\blacktriangleright$ buttons (33)
- 16** DISPLAY button (12)
- 17** TOP MENU button (33)
- 18** \mathbb{I}/\mathbb{O} (on/standby) button (28)
- 19** VOL (volume) +/- buttons (65)
The + button has a tactile dot.*
- 20** TV/VIDEO button (65)
- 21** ENTER button (performs the same function as **33**)
- 22** WIDE MODE button (65)
- 23** LOAD button (29)
- 24** DISC SKIP button (28)
- 25** ANGLE button (54)
- 26** PICTURE NAVI (picture navigation) button (45)
- 27** PICTURE MODE button (57)
- 28** SUR (surround) button (52)
- 29** REPLAY button (29)
- 30** SEARCH MODE button (44)
- 31** $\blacktriangleleft\|\blacktriangleright$ SCAN/SLOW buttons (31)
- 32** \blacksquare STOP button (29)
- 33** ENTER button (25)
- 34** \curvearrowright RETURN button (30)
- 35** MENU button (33) (35)

* Use the tactile dot as a reference when operating the player.

Guide to the Control Menu Display

Use the Control Menu to select a function and to view related information. Press DISPLAY repeatedly to turn on or change the Control Menu display as follows:

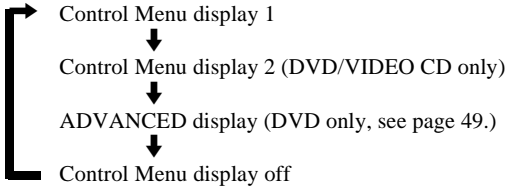

Hint

You can skip the ADVANCED display by setting “OFF” under “ADVANCED” in the Control Menu (page 49).

Control Menu

The Control Menu display 1 and 2 will show different items depending on the disc type. For details, please refer to the pages in parentheses.



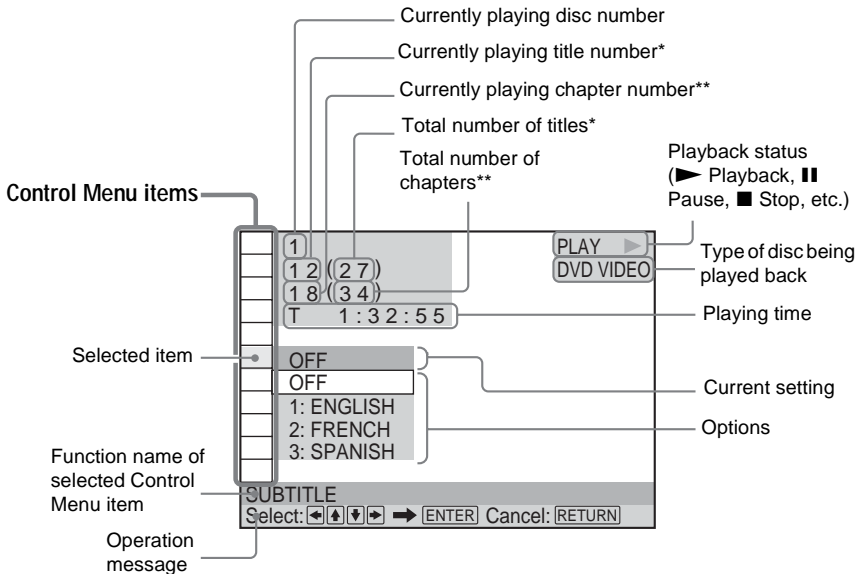











Example: Control Menu display 1 when playing a DVD VIDEO













* Displays the scene number for VIDEO CDs (PBC is on), track number for VIDEO CDs/CDs, album number for DATA CDs.



**Displays the index number for VIDEO CDs/CDs, MP3 audio track number for DATA CDs.

List of Control Menu Items

Item	Item Name, Function, Relevant Disc Type
	DISC (page 44) Selects the disc to be played. DVD-V DVD-RW VCD CD DATA CD
	TITLE (page 44)/SCENE (page 44)/TRACK (page 44) Selects the title, scene, or track to be played. DVD-V DVD-RW VCD
	CHAPTER (page 44)/INDEX (page 44) Selects the chapter or index to be played. DVD-V DVD-RW VCD
	ALBUM (page 44) Selects the album to be played. DATA CD
	TRACK (page 44) Selects the track to be played. CD DATA CD
	INDEX (page 44) Selects the index to be played. CD
	ORIGINAL/PLAY LIST (page 33) Selects the type of titles (DVD-RW) to be played, the ORIGINAL one, or an edited PLAY LIST. DVD-RW
	TIME/TEXT (page 44) Checks the elapsed time and the remaining playback time. Input the time code for picture and music searching. Displays the DVD/CD text or the DATA CD's track name. DVD-V DVD-RW VCD CD DATA CD
	AUDIO (page 51) Changes the audio setting. DVD-V DVD-RW VCD CD DATA CD
	SUBTITLE (page 55) Displays the subtitles. Changes the subtitle language. DVD-V DVD-RW
	ANGLE (page 54) Changes the angle. DVD-V
	TVS (page 52) Selects the surround functions. DVD-V
	ADVANCED (page 49) Displays the information (bit rate or layer) of the disc currently playing. DVD-V DVD-RW
	PARENTAL CONTROL (page 60) Set to prohibit playback on this player. DVD-V VCD CD

	<p>SETUP (page 67) QUICK Setup Use Quick Setup to choose the desired language of the on-screen display, the aspect ratio of the TV, the audio output, and the appropriate speaker settings. CUSTOM Setup In addition to the Quick Setup setting, you can adjust other various settings. RESET Returns the settings in “SETUP” to the default setting.</p> <p style="text-align: right;">DVD-V DVD-RW VCD CD DATA CD</p>
	<p>ALL DISCS/ONE DISC (page 38) Selects All Discs or One Disc mode.</p> <p style="text-align: right;">DVD-V DVD-RW VCD CD DATA CD</p>
	<p>PROGRAM (page 38) Selects the disc, title, chapter, or track to play in the order you want.</p> <p style="text-align: right;">DVD-V VCD CD</p>
	<p>SHUFFLE (page 40) Plays the disc, title, chapter, or track in random order.</p> <p style="text-align: right;">DVD-V DVD-RW VCD CD DATA CD</p>
	<p>REPEAT (page 41) Plays the entire disc (all titles/all tracks/all albums) repeatedly or one title/chapter/track/album repeatedly.</p> <p style="text-align: right;">DVD-V DVD-RW VCD CD DATA CD</p>
	<p>A-B REPEAT (page 42) Specifies the parts you want to play repeatedly.</p> <p style="text-align: right;">DVD-V DVD-RW VCD CD</p>
	<p>BNR (page 56) Adjusts the picture quality by reducing the “block noise” or mosaic like patterns that appear on your TV screen.</p> <p style="text-align: right;">DVD-V DVD-RW VCD</p>
	<p>CUSTOM PICTURE MODE (page 57) Adjusts the video signal from the player. You can select the picture quality that best suits the program you are watching.</p> <p style="text-align: right;">DVD-V DVD-RW VCD</p>
	<p>DIGITAL VIDEO ENHANCER (page 58) Exaggerates the outline of the image to produce a sharper picture.</p> <p style="text-align: right;">DVD-V DVD-RW VCD</p>
	<p>PICTURE NAVIGATION (page 45) Divides the screen into 9 subscreens to help you find the scene you want quickly.</p> <p style="text-align: right;">DVD-V VCD</p>

 **Hint**

The Control Menu icon indicator lights up in green  →  when you select any item except “OFF.” (“TVS,” “PROGRAM,” “SHUFFLE,” “REPEAT,” “A-B REPEAT,” “BNR,” “DIGITAL VIDEO ENHANCER” only). The “ANGLE” indicator lights up in green only when the angles can be changed. The “CUSTOM PICTURE MODE” indicator lights up in green when any setting other than “STANDARD” is selected.

Simple Start Guide

Quick Overview

A quick overview presented in this guide will give you enough information to start using the player for your enjoyment. To use the surround sound features of this player, refer to “Hookups” on page 18.

Notes

- You cannot connect this player to a TV that does not have a video input jack.
- Be sure to disconnect the power of each component before connecting.

Step 1: Unpacking

Check that you have the following items:

- Audio/video cord (pinplug × 3 ↔ pinplug × 3) (1)
- Remote commander (remote) (1)
- Size AA (R6) batteries (2)

Step 2: Inserting Batteries into the Remote

You can control the player using the supplied remote. Insert two Size AA (R6) batteries by matching the ⊕ and ⊖ ends on the batteries to the markings inside the compartment. When using the remote, point it at the remote sensor  on the player.

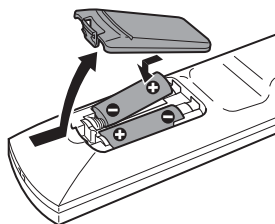

Notes

- Do not leave the remote in an extremely hot or humid place.
- Do not drop any foreign object into the remote casing, particularly when replacing the batteries.
- Do not expose the remote sensor to direct light from the sun or a lighting apparatus. Doing so may cause a malfunction.
- If you do not use the remote for an extended period of time, remove the batteries to avoid possible damage from battery leakage and corrosion.

Step 3: TV Hookups

Connect the supplied audio/video cord and the power cord in the order (1~3) shown below. Be sure to connect the power cord last.

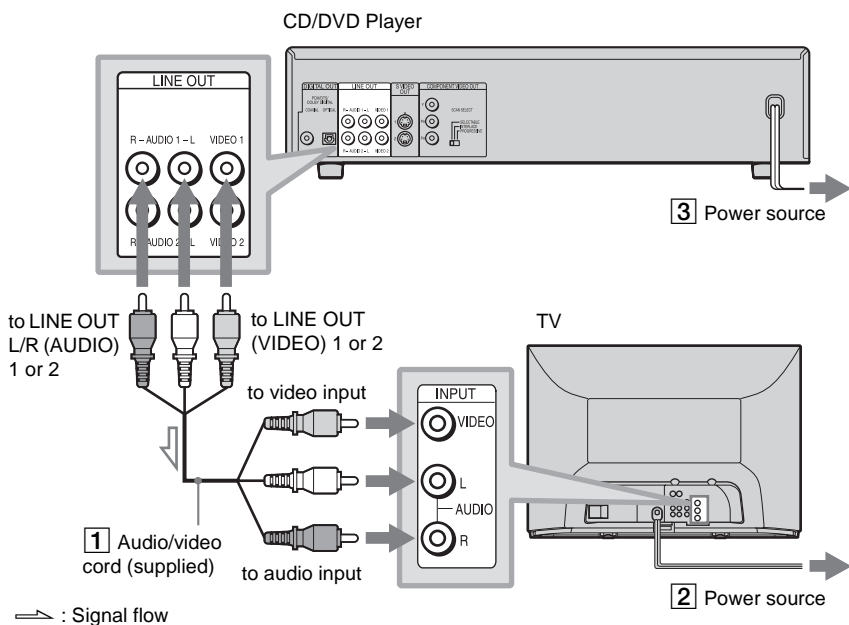

When connecting to a wide screen TV

Depending on the disc, the image of some discs may not fit your TV screen.

If you want to change the aspect ratio, please refer to page 69.

When connecting to a TV that accepts progressive (480p) format signal

You need to use the COMPONENT VIDEO OUT jacks to view progressive signals. Hook up your TV using pattern ④ on page 18, and then run Quick Setup on page 25.

Hint

When connecting to a monaural TV, use a stereo-mono conversion cord (not supplied). Connect the LINE OUT (VIDEO) jack on the player to the TV's video input jack, and connect the LINE OUT L/R (AUDIO) 1/2 jacks to the TV's audio input jack.

Step 4: Playing a Disc

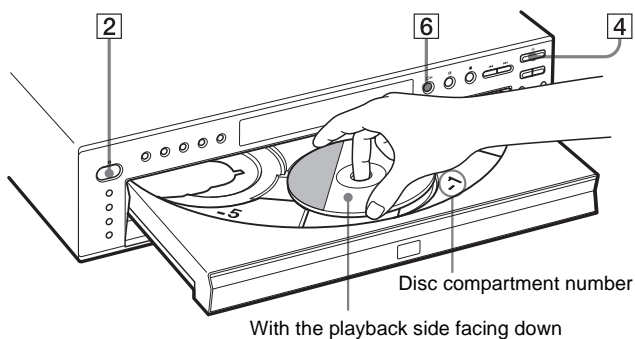

- 1** Turn on the TV.
- 2** Press **I/⏻** on the player.
- 3** Switch the input selector on your TV so that the signal from the player appears on the TV screen.
- 4** Press **⏻** on the player to open the disc tray.
- 5** Place the disc on the tray with the playback side facing down.
- 6** Press **▶**.
The disc tray closes and the player begins playing the disc.

After Step 6

Depending on the disc, a menu may be displayed on the TV screen. If so, select the item you want from the menu and play the DVD VIDEO (page 33) or VIDEO CD disc (page 34).

To stop playing

Press **■**.

To remove the disc

Press **⏻**.

To turn off the player

Press **I/⏻**. The player enters standby mode and the power indicator lights up in red.

Hooking Up the Player

Follow Steps 1 to 4 to hook up and adjust the settings of the player. Before you start, disconnect the power cords, check that you have all of the supplied accessories, and insert the batteries into the remote (page 15).

Notes

- Plug cords securely to prevent unwanted noise.
- Refer to the instructions supplied with the components to be connected.

Step 1: Connecting the Video Cords

Connect this player to your TV monitor, projector, or AV amplifier (receiver) using a video cord. Select one of the patterns **A** through **C**, according to the input jack on your TV monitor, projector, or AV amplifier (receiver).

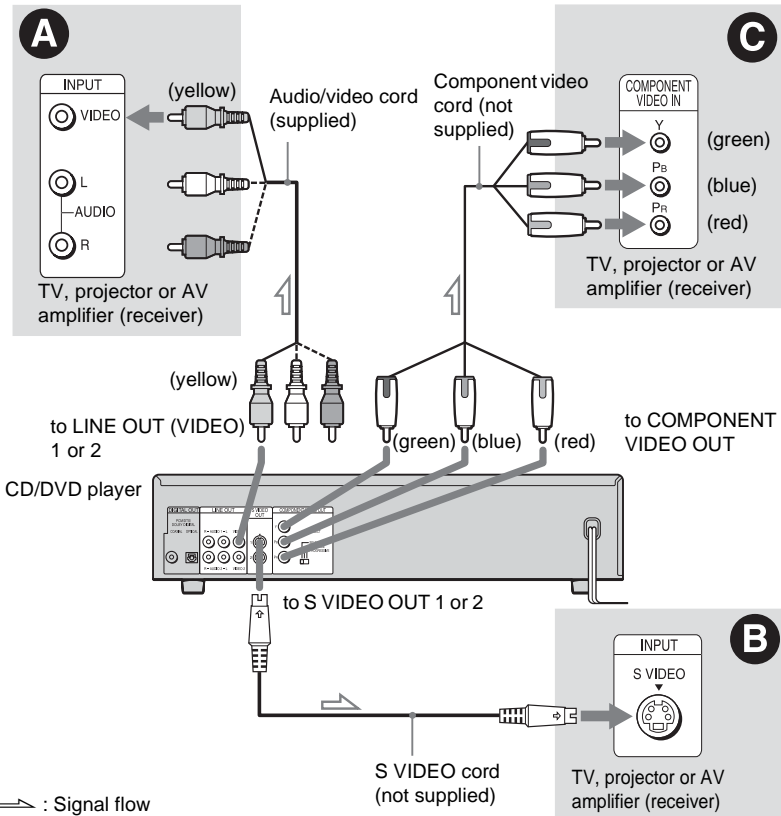

A If you are connecting to a video input jack

Connect the yellow plug of the audio/video cord (supplied) to the yellow (video) jacks. You will enjoy standard quality images.



Use the red and white plugs to connect to the audio input jacks (page 21). (Do this if you are connecting to a TV only.)

B If you are connecting to an S VIDEO input jack

Connect an S VIDEO cord (not supplied). You will enjoy high quality images.



C If you are connecting to a monitor, projector, or AV amplifier (receiver) having component video input jacks (Y/P_B/P_R)

Connect the component via the COMPONENT VIDEO OUT jacks using a component video cord (not supplied) or three video cords (not supplied) of the same kind and length. You will enjoy accurate color reproduction and high quality images. If your TV accepts progressive (480p) format signals, you must use this connection and set "COMPONENT OUT" to "PROGRESSIVE" in "SCREEN SETUP" (page 69).

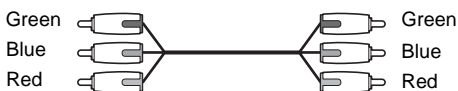

Notes

- Connect the player directly to the TV. If you pass the player signals via the VCR, you may not receive a clear image on the TV screen.

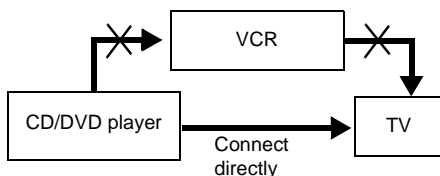

- Consumers should note that not all high definition television sets are fully compatible with this product and may cause artifacts to be displayed in the picture. In the case of 480 progressive scan picture problems, it is recommended that you switches the connection to the standard definition output. If there are questions regarding your Sony TV set's compatibility with this model 480p DVD player, please contact our customer service center.

Step 2: Connecting the Audio Cords

Refer to the chart below to select the connection that best suits your system. Be sure to also read the instructions for the components you wish to connect.

Select a connection

Select one of the following connections, **A** through **D**.

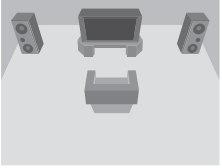
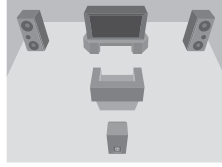
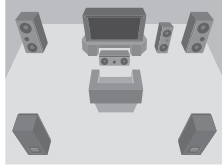
Components to be connected	Connection	Your setup
<u>TV</u> <ul style="list-style-type: none"> Surround effects: TVS DYNAMIC (page 53), TVS WIDE (page 53) 	A (page 21)	Example 
<u>Stereo amplifier (receiver) and two speakers</u> <ul style="list-style-type: none"> Surround effects: TVS STANDARD (page 53) or MD deck/DAT deck Surround effects: none 	B (page 22)	Example 
<u>AV amplifier (receiver) having a Dolby* Surround (Pro Logic) decoder and 3 to 6 speakers</u> <ul style="list-style-type: none"> Surround effects: Dolby Surround (Pro Logic) (page 73) 	C (page 23)	Example 
<u>AV amplifier (receiver) with a digital input jack having a Dolby Digital or DTS** decoder and 6 speakers</u> <ul style="list-style-type: none"> Surround effects: Dolby Digital (5.1ch) (page 73), DTS (5.1ch) (page 73) 	D (page 24)	Example 

* Manufactured under license from Dolby Laboratories. "Dolby," "Pro Logic," and the double-D symbol are trademarks of Dolby Laboratories.

**"DTS" and "DTS Digital Out" are trademarks of Digital Theater Systems, Inc.

A Connecting to your TV

This connection will use your TV speakers for sound.

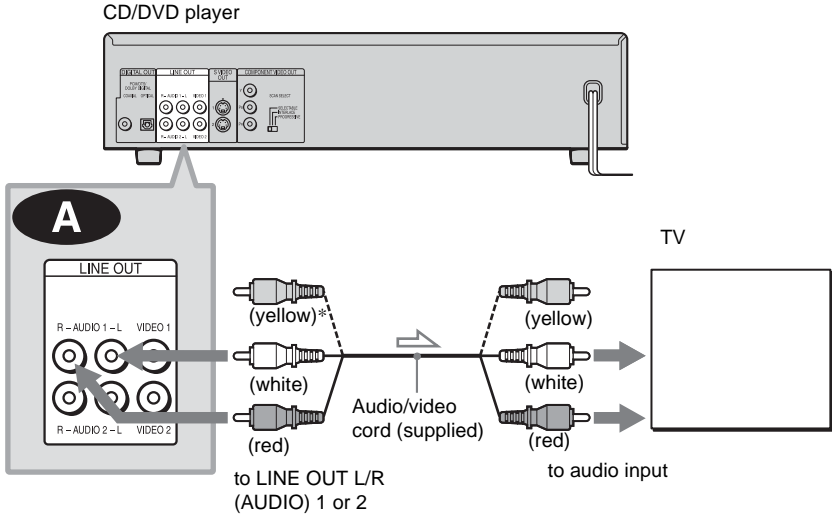

⇒ : Signal flow

* The yellow plug is used for video signals (page 18).

Hint

When connecting to a monaural TV, use a stereo-mono conversion cord (not supplied). Connect the LINE OUT L/R (AUDIO) jacks to the TV's audio input jack.

B Connecting to a stereo amplifier (receiver) and 2 speakers/Connecting to an MD deck or DAT deck

If the stereo amplifier (receiver) has audio input jacks L and R only, use **B-1**. If the amplifier (receiver) has a digital input jack, or when connecting to an MD deck or DAT deck, use **B-2**. In this case, you can also connect the player directly to the MD deck or DAT deck without using your stereo amplifier (receiver).

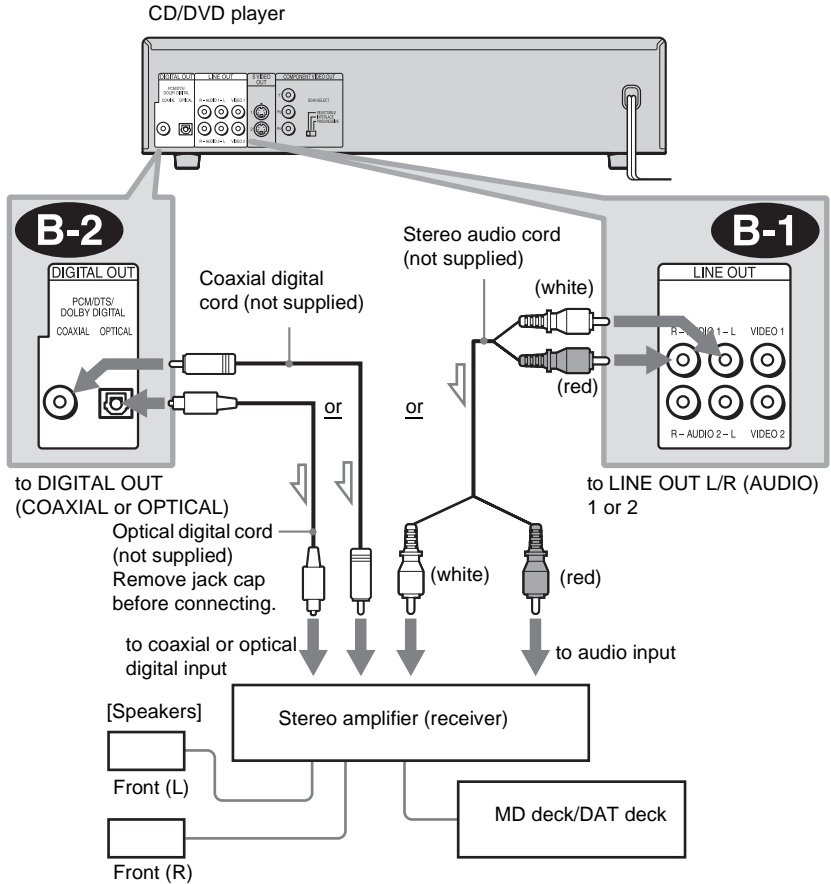

⇒: Signal flow

Hint

In connection **B-1**, you can use the supplied audio/video cord instead of using a separate stereo audio cord.

Note

If you select one of the TVS effects (page 52) while playing a disc, no sound will come from your speakers with the **B-2** connection.

C Connecting to an AV amplifier (receiver) having a Dolby Surround (Pro Logic) decoder and 3 to 6 speakers

You can enjoy the Dolby Surround effects only when playing Dolby Surround audio or multi-channel audio (Dolby Digital) discs.

If your amplifier (receiver) has L and R audio input jacks only, use **C-1**. If your amplifier (receiver) has a digital input jack, use **C-2**.

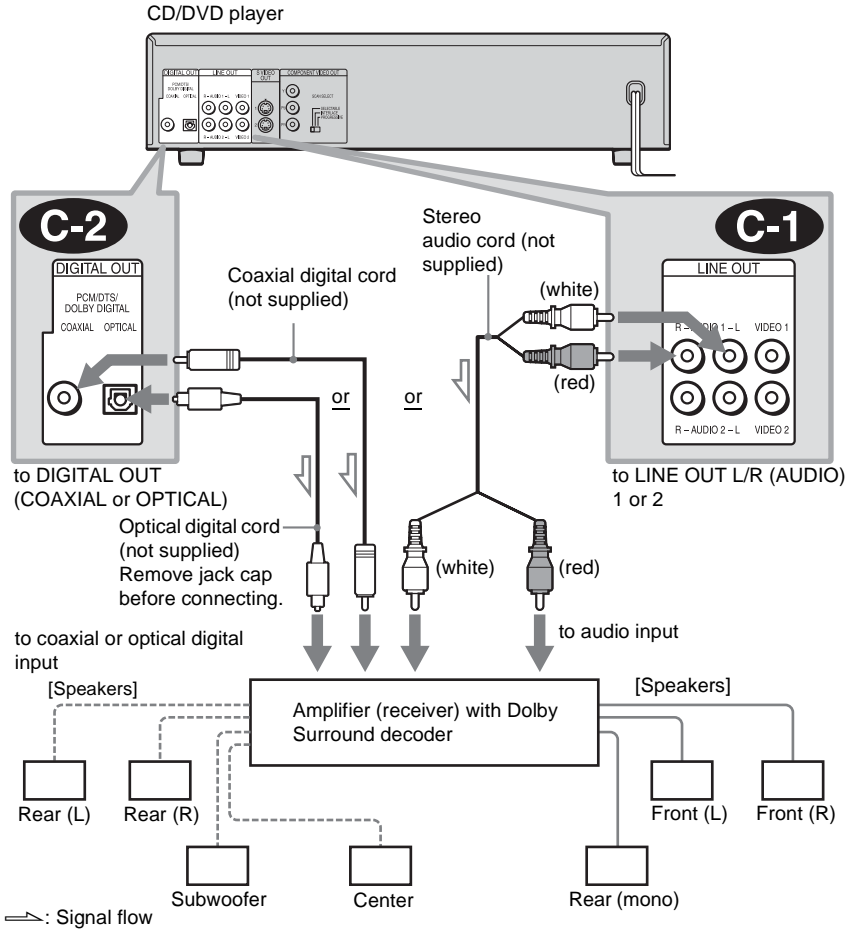

Note

When connecting 6 speakers, replace the monaural rear speaker with a center speaker, 2 rear speakers and a subwoofer.

D Connecting to an AV amplifier (receiver) with a digital input jack having a Dolby Digital, or DTS decoder and 6 speakers

This connection will allow you to use the Dolby Digital, or DTS decoder function of your AV amplifier (receiver). You are unable to enjoy the surround sound effects of this player.

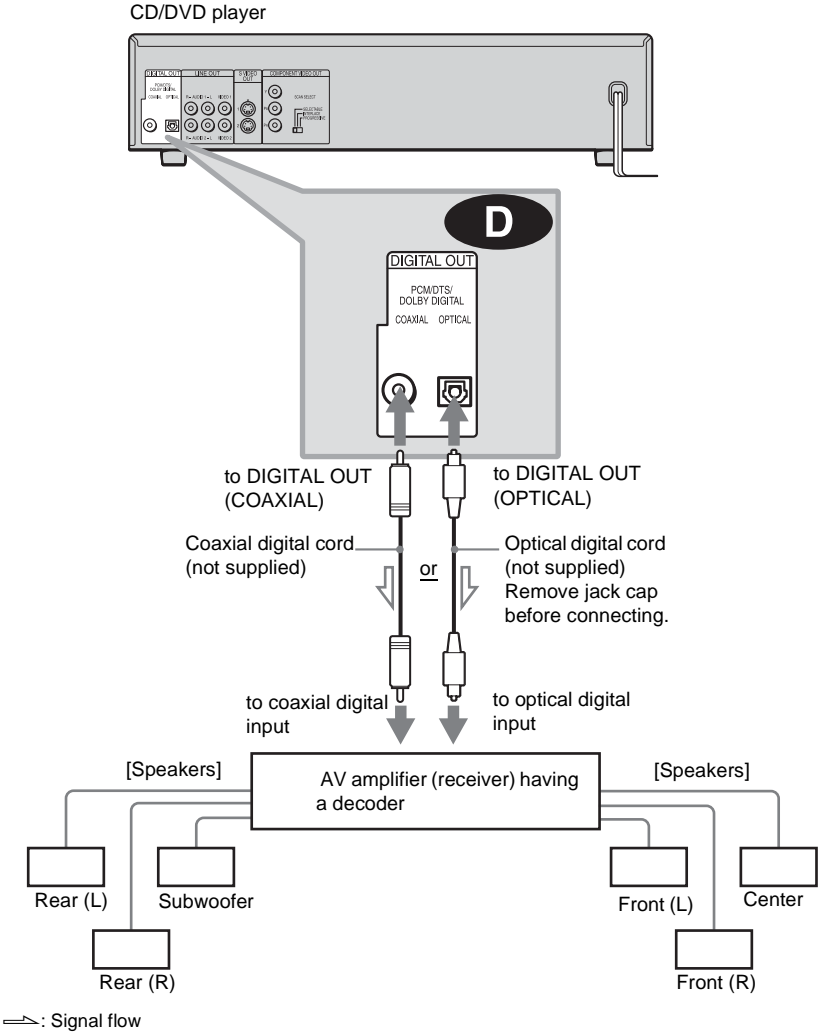

Note

After you have completed the connection, be sure to set "DOLBY DIGITAL" to "DOLBY DIGITAL" and "DTS" to "ON" in Quick Setup (page 25).

Step 3: Connecting the Power Cord

Plug the player and TV power cords into an AC outlet.

Step 4: Quick Setup

Follow the steps below to make the minimum number of basic adjustments for using the player. To skip an adjustment, press **▶▶▶**. To return to the previous adjustment, press **◀◀◀**. The on-screen display differs depending on the player model.

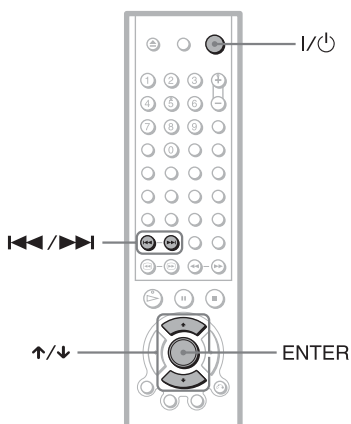

1 Turn on the TV.

2 Press I/Power.

3 Switch the input selector on your TV so that the signal from the player appears on the TV screen.

“Press [ENTER] to run QUICK SETUP.” appears at the bottom of the screen. If this message does not appear, select “QUICK” under “SETUP” in the Control Menu to run Quick Setup (page 68).

4 Press ENTER without inserting a disc.

The Setup Display for selecting the language used in the on-screen display appears.

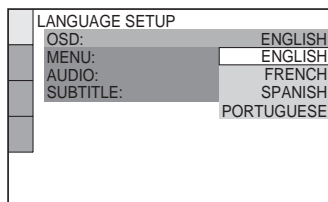

5 Press Up/Down to select a language.

The player uses the language selected here to display the menu and subtitles as well.

6 Press ENTER.

The Setup Display for selecting the aspect ratio of the TV to be connected appears.

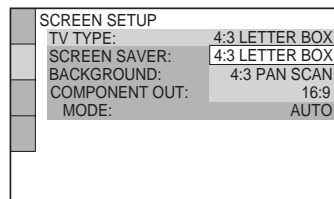

7 Press \uparrow/\downarrow to select the setting that matches your TV type.

- ◆ If you have a 4:3 standard TV
 - 4:3 LETTER BOX or 4:3 PAN SCAN (page 69)
- ◆ If you have a wide-screen TV or a 4:3 standard TV with a wide-screen mode
 - 16:9 (page 69)

8 Press ENTER.

The Setup Display for selecting the type of video signal appears.

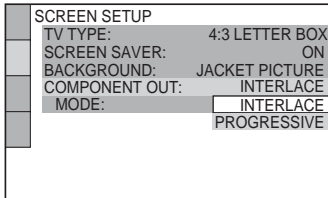

9 Press \uparrow/\downarrow to select the type of signals you wish to output to your TV.

Select “PROGRESSIVE” only if you have made video connection **C** (page 18) and wish to view progressive video signals.

- ◆ If you have an Interlace format TV (standard TV)
 - INTERLACE (page 69)
- ◆ If you have a Progressive format TV
 - PROGRESSIVE (page 69)

10 Press ENTER.

The Setup Display for selecting the type of jack used to connect your amplifier (receiver) appears.

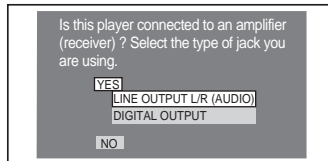

11 Press \uparrow/\downarrow to select the type of jack (if any) you are using to

connect to an amplifier (receiver), then press ENTER.

Choose the item that matches the audio connection you selected on pages 21 to 24 (**A** through **D**).

- A**
 - If you connect just a TV and nothing else, select “NO.” Quick Setup is finished and connections are complete.

- B-1 C-1**
 - Select “LINE OUTPUT L/R (AUDIO).” Quick Setup is finished and connections are complete.

- B-2 C-2 D**
 - Select “DIGITAL OUTPUT.” The Setup Display for “DOLBY DIGITAL” appears.

12 Press \uparrow/\downarrow to select the type of Dolby Digital signal you wish to send to your amplifier (receiver).

Choose the signal that matches the audio connection you selected on pages 22 to 24 (**B** through **D**).

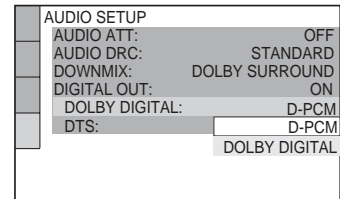

- B-2 C-2**
 - D-PCM (page 73)

- D**
 - DOLBY DIGITAL (only if the amplifier (receiver) has a Dolby Digital decoder) (page 73)

13 Press ENTER.

“DTS” is selected.

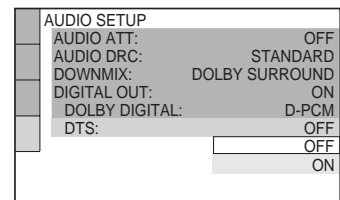

14 Press **↑/↓** to select whether or not you wish to send a DTS signal to your amplifier (receiver).

Choose the item that matches the audio connection you selected on pages 22 to 24 (**B** through **D**).

B-2 **C-2**

- OFF (page 73)

D

- ON (only if the amplifier (receiver) has a DTS decoder) (page 73)

15 Press **ENTER**.

Quick Setup is finished. All connections and setup operations are complete.

Enjoying the surround sound effects

To enjoy the surround sound effects of this player or your amplifier (receiver), set the following items as described below for the audio connection you selected on pages 22 to 24 (**B** through **D**). Each of these is the default setting and does not need to be adjusted when you first connect the player. Refer to page 67 for using the Setup Display.

Audio Connection (pages 21 to 24)

A

- No additional settings are needed.

B-1 **C-1**

- Set “DOWNMIX” to “DOLBY SURROUND” (page 73).
- If the sound distorts even when the volume is turned down, set “AUDIO ATT” to “ON” (page 72).

B-2 **C-2** **D**

- Set “DOWNMIX” to “DOLBY SURROUND” (page 73).
- Set “DIGITAL OUT” to “ON” (page 73).

Playing Discs

Playing Discs **DVD-V**

DVD-RW **VCD** **CD** **DATA CD**

Depending on the DVD or VIDEO CD, some operations may be different or restricted. Refer to the operating instructions supplied with your disc.

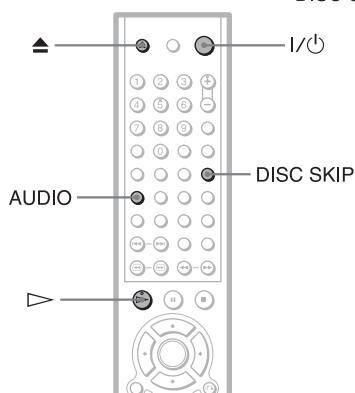
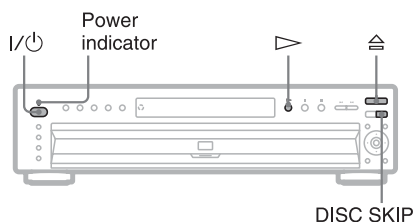

1 Turn on your TV.

2 Press I/⏻.

The player turns on and the power indicator lights up in green.

3 Switch the input selector on your TV so that the signal from the player appears on the TV screen.

◆ **When using an amplifier (receiver)**

Turn on the amplifier (receiver) and select the appropriate channel so that you can hear sound from the player.

4 Press  on the player, and place a disc on the disc tray.

To place other discs on the tray, press DISC SKIP and place the discs in the order you want to play them.

Each time you press DISC SKIP, the disc tray turns so you can place the discs on the empty compartments. The player plays from the last disc placed on the tray.

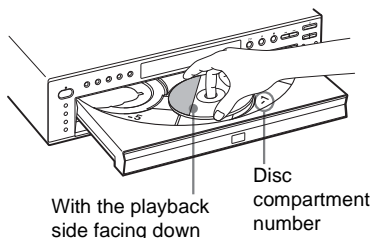

5 Press .

The disc tray closes, and the player starts playback (continuous play). Adjust the volume on the TV or the amplifier (receiver).

Depending on the disc, a menu may appear on the TV screen. For DVD VIDEOS, see page 33. For VIDEO CDs, see page 34.

To turn off the player

Press I/⏻. The player enters standby mode.

Hint

You can have the player turn off automatically whenever you leave it in stop mode for more than 30 minutes. To turn on this function, set "AUTO POWER OFF" in "CUSTOM SETUP" to "ON" (page 71).

Notes on playing DTS sound tracks on a CD

- When playing DTS-encoded CDs, excessive noise will be heard from the analog stereo jacks. To avoid possible damage to the audio system, the consumer should take proper precautions when the analog stereo jacks of the player are connected to an amplification system. To enjoy DTS Digital Surround™ playback, an external 5.1-channel decoder system must be connected to the digital jack of the player.

- Set the sound to “STEREO” using the AUDIO button when you play DTS sound tracks on a CD (page 51).
- Do not play DTS sound tracks without first connecting the player to an audio component having a built-in DTS decoder. The player outputs the DTS signal via the DIGITAL OUT (COAXIAL or OPTICAL) jack even if “DTS” in “AUDIO SETUP” is set to “OFF” in the Setup Display (page 73), and may affect your ears or cause your speakers to be damaged.

Notes on playing DVD VIDEOS with a DTS sound track

- DTS audio signals are output only through the DIGITAL OUT (COAXIAL or OPTICAL) jack.
- When you play a DVD VIDEO with DTS sound tracks, set “DTS” to “ON” in “AUDIO SETUP” (page 73).
- If you connect the player to audio equipment without a DTS decoder, do not set “DTS” to “ON” in “AUDIO SETUP” (page 73). A loud noise may come out from the speakers, affecting your ears or causing the speakers to be damaged.

Additional operations

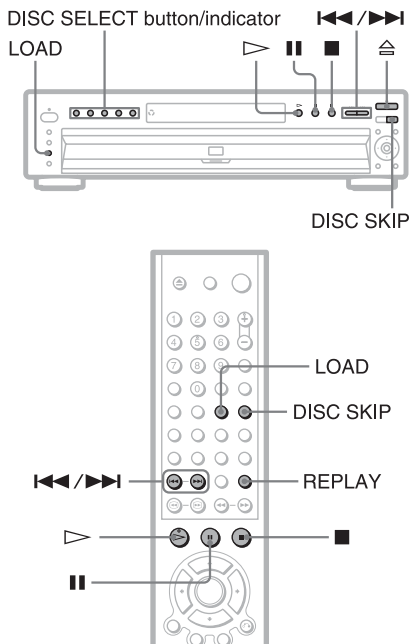

To	Operation
Select a disc	Press DISC SELECT 1–5 on the player
Stop	Press ■
Pause	Press ■■
Resume play after pause	Press ■■ or ▷
Go to the next disc	Press DISC SKIP
Go to the next chapter, track, or scene in continuous play mode	Press ►►
Go back to the previous chapter, track, or scene in continuous play mode	Press ◀◀
Stop play and remove the disc	Press ▲
Replay the previous scene (DVD VIDEO only)	Press REPLAY
Check if a disc is in the disc compartment	Press LOAD. The DISC SELECT indicator for each compartment (1 – 5) containing a disc lights up. The disc number indicators on the front panel display (1–5) light up.

💡 Hints

- The Replay function is useful when you want to review a scene or dialog that you missed.
- Before loading the discs, a disc number indicator of an empty compartment may be lit.

Note

You may not be able to use the Replay function with some scenes.

Replacing discs while playing a disc (EXCHANGE)

You can open the disc tray while playing a disc so that you can check which discs are to be played next and replace discs without interrupting playback of the current disc.

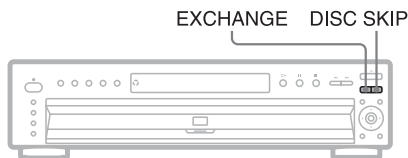

- 1 Press EXCHANGE.**
The disc tray opens and two disc compartments appear. Even if the player is playing a disc, it doesn't stop playing.
- 2 Replace the discs in the compartments with new ones.**
- 3 Press DISC SKIP.**
The disc tray turns and another two disc compartments appear.
- 4 Replace the discs in the compartments with new ones.**
- 5 Press EXCHANGE.**
The disc tray closes.

Hint

While the disc tray is open,

- If the playback of the current disc ends, the player stops playing. If the disc is played in One Disc Repeat Play mode (page 41), the current disc starts playing again.
- In All Discs Shuffle Play mode (page 40), titles/tracks/chapters are reshuffled only on the current disc.
- In Program Play mode (page 38), the titles/tracks/chapters only on the current disc are played.



Note

Do not push the disc tray to close in Step 5, as you may damage the player.

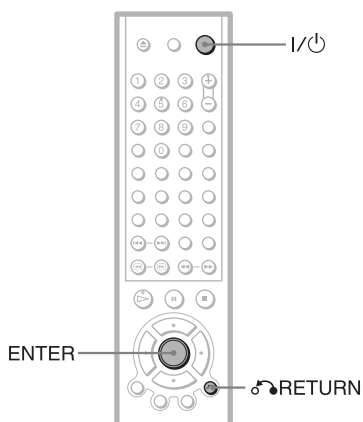

Locking the disc tray (Child Lock)

You can lock the disc tray to prevent children from opening it.





When the player is in standby mode, press  RETURN, ENTER, and then  I/⏻ on the remote.

The player turns on and “LOCKED” appears on the front panel display.

The  and EXCHANGE buttons on the player and the  button on the remote do not work while the Child Lock is set.

To unlock the disc tray

When the player is in standby mode, press  RETURN, ENTER, and then  I/⏻ again.

Note

Even if you select “RESET” under “SETUP” in the Control Menu (page 68), the disc tray remains locked.

Searching for a Particular Point on a Disc (Scan, Slow-motion Play, Search, Freeze Frame)

You can quickly locate a particular point on a disc by monitoring the picture or playing back slowly.

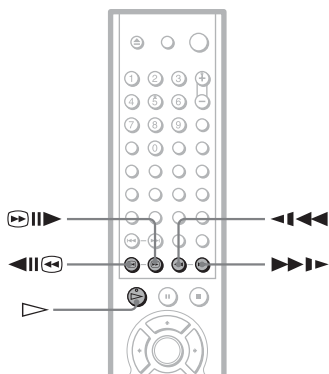

Note

Depending on the DVD/VIDEO CD, you may not be able to do some of the operations described.

Locating a point quickly (Search)

DVD-V DVD-RW VCD CD DATA CD

During playback, keep pressing **FF1** to locate a point in the playback direction or keep pressing **FR1** to locate a point in the opposite direction. When you find the point you want, release the button to return to normal playback speed.

Locating a point quickly by playing a disc in fast forward or fast reverse (Scan)

VCD CD DATA CD

Press **FF1** or **FR1** while playing a disc. When you find the point you want, press **Play/Pause** to return to normal speed. Each time you press **FF1** or **FR1** during scan, the playback speed changes. Three speeds are

available. With each press the indication changes as follows:

Playback direction

×2 (DVD/CD only) → **FF1** → **FF2**

Opposite direction

×2 (DVD only) → **FR1** → **FR2**

The “**×2**”/“**×2**” playback speed is about twice the normal speed. The “**FF2**”/“**FR2**” playback speed is faster than **FF1** / **FR1**.”

Watching frame by frame (Slow-motion play)

DVD-V DVD-RW VCD

Press **FR1** or **FF1** when the player is in pause mode. To return to the normal speed, press **Play/Pause**.

Each time you press **FR1** or **FF1** during Slow-motion play, the playback speed changes. Two speeds are available. With each press the indication changes as follows:

Playback direction

SLOW2 ↔ **SLOW1**

Opposite direction (DVD only)

SLOW2 ↔ **SLOW1**

The “**SLOW2**”/“**SLOW2**” playback speed is slower than “**SLOW1**”/“**SLOW1**”.

Playing one frame at a time

DVD-V DVD-RW VCD

When the player is in the pause mode, press **FF1** to go to the next frame. Press **FR1** to go to the preceding frame (DVD only). If you hold the button down, you can view the frames in succession. To return to normal playback, press **Play/Pause**.

Resuming Playback from the Point Where You Stopped the Disc (Resume Play/Multi-disc Resume)

The player remembers the point where you stopped the disc.

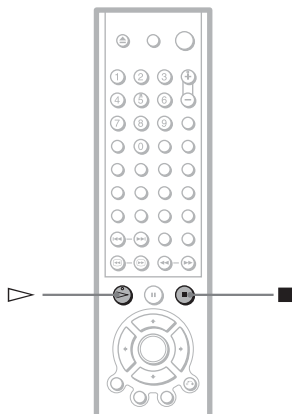

Resuming playback for the current disc (Resume Play) **DVD-V**

DVD-RW **VCD** **CD** **DATA CD**

The player remembers the point where you stopped the disc even if the player enters standby mode by pressing **I/P**.

1 While playing a disc, press **■** to stop playback.

“RESUME” appears on the front panel display.

2 Press **▷**.

The player starts playback from the point where you stopped the disc in Step 1.

Hint

To play from the beginning of the disc, press **■** twice, then press **▷**.

Notes

- The point where you stopped playing is cleared when:
 - you change the play mode.
 - you do Program Play or Shuffle Play
 - you change the settings on the Setup Display.
 - you open the disc tray.
 - you disconnect the power cord.
- When playing a CD and DVD-RW (VR mode), the point where you stopped is cleared when the disc tray is opened or the power cord is disconnected.
- When playing a DATA CD, the point where you stopped playing is cleared when the player enters standby mode, the disc tray is opened, or the power cord is disconnected.
- This function may not work with some discs.

Storing the point where you stopped the disc (Multi-disc Resume) **DVD-V** **VCD**

The player stores the point where you stopped the disc and resumes playback from the same point the next time you insert the same disc. The player remembers the stopped point of the disc even after you play other discs in the disc tray.

Resume playback points for up to 40 different DVD VIDEO/VIDEO CD discs remain in memory even if you disconnect the power cord. When you store a resume playback point for the 41st disc, the resume playback point for the first disc is deleted.

Hints

- To play from the beginning of the disc, press **■** twice, then press **▷**.
- To turn off the Multi-disc Resume function, set “MULTI-DISC RESUME” in “CUSTOM SETUP” to “OFF” (page 72). Playback restarts at the resume point only for the current disc in the player.

Note

This function may not work with some discs.

Using the DVD's Menu

DVD-V

A DVD is divided into long sections of a picture or a music feature called "titles." When you play a DVD which contains several titles, you can select the title you want using the TOP MENU button. When you play DVDs that allow you to select items such as the language for the subtitles and the language for the sound, select these items using the MENU button.

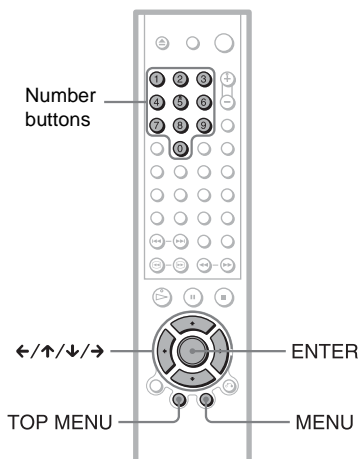

- 1 Press TOP MENU or MENU.**
The disc's menu appears on the TV screen.
The contents of the menu vary from disc to disc.
- 2 Press ←/↑/↓/→ or the number buttons to select the item you want to play or change.**
- 3 Press ENTER.**

Hint

You can also display the disc's menu by pressing the TOP MENU or MENU button on the player.

Selecting "ORIGINAL" or "PLAY LIST" on a DVD-RW Disc

DVD-RW

Some DVD-RW discs in VR (Video Recording) mode have two types of titles for playback: originally recorded titles (ORIGINAL) and titles that can be created on recordable DVD players for editing (PLAY LIST). You can select the type of titles to be played.

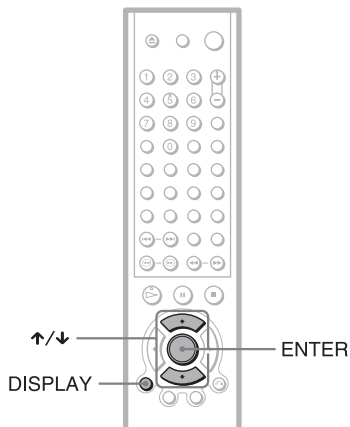

- 1 Press DISPLAY in stop mode.**
The Control Menu appears.
- 2 Press ↑/↓ to select (ORIGINAL/PLAY LIST), then press ENTER.**
The options for "ORIGINAL/PLAY LIST" appear.

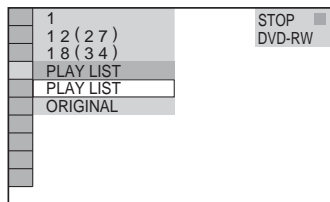

Hint

To play without using PBC, press **◀◀/▶▶** while the player is stopped to select a track, then press **▷** or ENTER.

“Play without PBC.” appears on the TV screen and the player starts continuous play. You cannot play still pictures such as a menu.

To return to PBC playback, press **■** twice then press **▷**.

Note

Depending on the VIDEO CD, “Press ENTER” in Step 3 may appear as “Press SELECT” in the instructions supplied with the disc. In this case, press **▷**.

Playing an MP3 Audio Track **DATA CD**

You can play back DATA CDs (CD-ROMs/CD-Rs/CD-RWs) recorded in MP3 (MPEG1 Audio Layer 3) format.

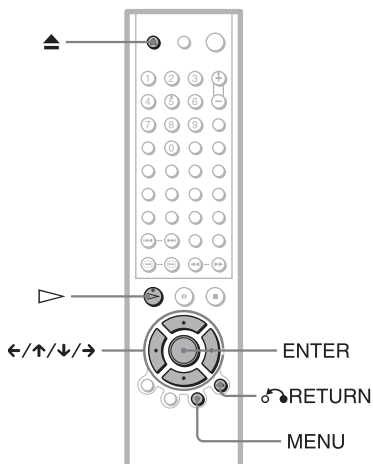

1 Press **▲** and place a DATA CD on the disc tray.

2 Press **▷**.

The disc tray closes, and the player starts to play the first MP3 audio track in the first album on the disc.

Notes

- This player can play MP3 audio tracks recorded in the following sampling frequencies: 32 kHz, 44.1 kHz, 48 kHz.
- The playback order may be different from the edited order. See “The playback order of MP3 audio tracks” (page 37) for details.

Selecting an album and track

1 Press MENU.

The list of MP3 albums recorded on the DATA CD appears.

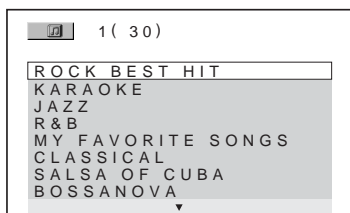

2 Select an album using \uparrow/\downarrow and press ENTER.

The list of tracks contained in the album appears.

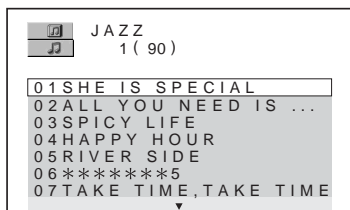

3 Select a track using \uparrow/\downarrow and press ENTER.

The selected track starts playing.
When a track or album is being played, its title is shaded.

To go to the next or previous page

Press \rightarrow or \leftarrow .

To return to the previous display

Press \curvearrowright RETURN.

To turn off the display

Press MENU.

Notes

- Only the letters in the alphabet and numbers can be used for album or track names. Anything else is displayed as “*”.
- ID3 tags cannot be displayed.

About MP3 audio tracks

You can play MP3 audio tracks on CD-ROMs, CD-Rs, or CD-RWs. However, the discs must be recorded according to ISO9660 level 1, level 2, or Joliet format for the player to recognize the tracks.

You can also play discs recorded in Multi Session.

See the instructions of the CD-R/RW device or recording software (not supplied) for details on the recording format.

To play a Multi Session CD

This player can play Multi Session CDs when an MP3 audio track is located in the first session. Any subsequent MP3 audio tracks, recorded in the later sessions, can also be played back.

When audio tracks and images in music CD format or Video CD format are recorded in the first session, only the first session will be played back.

Notes

- If you put the extension “.MP3” to data not in MP3 format, the player cannot recognize the data properly and will generate a loud noise which could damage your speaker system.
- The player cannot play audio tracks in MP3PRO format.

The playback order of MP3 audio tracks

The playback order of albums and tracks recorded on a DATA CD is as follows.

◆ Structure of disc contents

Tree 1 Tree 2 Tree 3 Tree 4 Tree 5

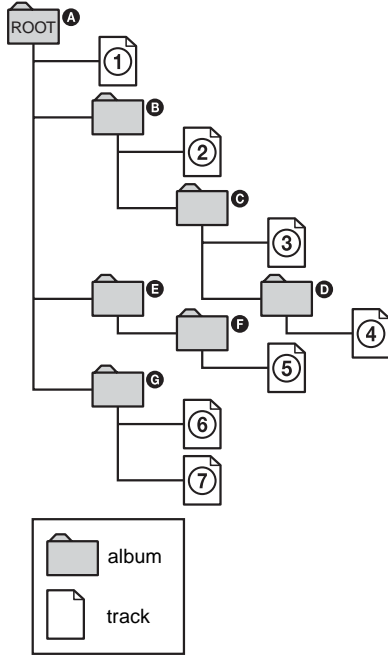

When you insert a DATA CD and press \blacktriangleright , the numbered tracks are played sequentially, from ① through ⑦. Any sub-albums/tracks contained within a currently selected album take priority over the next album in the same tree. (Example: **C** contains **D** so ④ is played before ⑤.)

When you press MENU and the list of MP3 albums appears (page 36), the albums are arranged in the following order: **A** → **B** → **C** → **D** → **F** → **G**. Albums that do not contain tracks (such as album **E**) do not appear in the list.

💡 Hints

- If you add numbers (01, 02, 03, etc.) to the front of the track names, the tracks will be played in that order.
- Since a disc with many trees takes longer to start playback, it is recommended that you create the albums no more than two trees.

Notes

- Depending on the software you use to create the DATA CD, the playback order may differ from the illustration above.
- The playback order above may not be applicable if there are more than a total of 999 albums and tracks in the DATA CD.
- The player can recognize up to 499 albums (the player will count just albums, including albums that do not contain MP3 audio tracks). The player will not play any albums beyond the first 499 albums. Of the first 499 albums, the player will play no more than a combined total of 999 albums and tracks.

Various Play Mode Functions (Program Play,

Shuffle Play, Repeat Play, A-B Repeat Play)

You can set the following play modes:

- Program Play (page 38)
- Shuffle Play (page 40)
- Repeat Play (page 41)
- A-B Repeat Play (page 42)

Note

The play mode is canceled when:

- you open the disc tray.
- the player enters standby mode by pressing .

Selecting the disc mode (One Disc or All Discs)

You can play one disc or all of the discs in the player. Before setting Program Play, Shuffle Play, or Repeat Play, you must select whether to set those play mode on one disc or all of the discs.

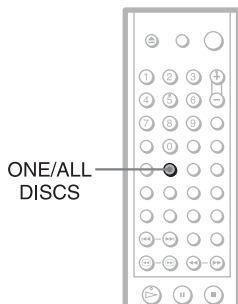

- 1 Press ONE/ALL DISCS (ONE/ALL on the player) during playback.

The following display appears.

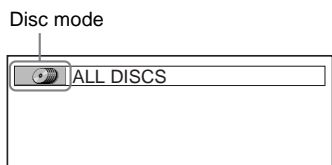

Each time you press the button, (ONE DISC) or (ALL DISCS) is selected alternately.

Hint

You can also select "ALL DISCS/ONE DISC" from the Control Menu (page 12).

Creating your own program (Program Play)

You can play the contents of a disc in the order you want by arranging the order of the titles, chapters, or tracks on the disc to create your own program.

You can program up to 99 items. By selecting All Discs mode (page 38), you can create a program for all of the discs in the player.

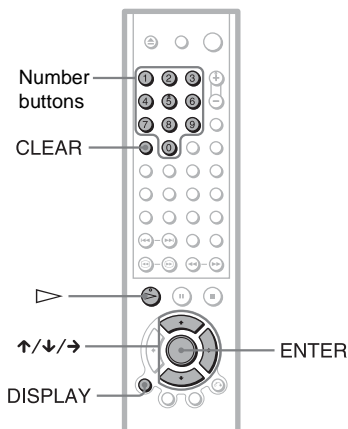

- 1 Press DISPLAY twice (when playing a CD, press once).
The Control Menu appears.
- 2 Press to select (PROGRAM), then press ENTER.
The options for "PROGRAM" appear.

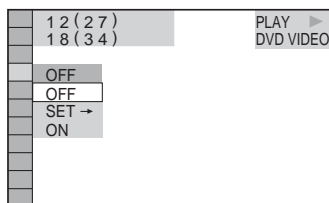

3 Press \uparrow/\downarrow to select "SET \rightarrow " then press ENTER.

The display for programming appears.

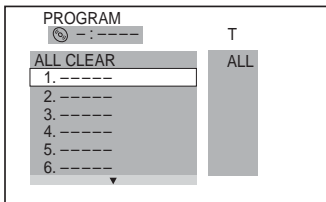

4 Press \rightarrow .

The player is ready to program the first disc.

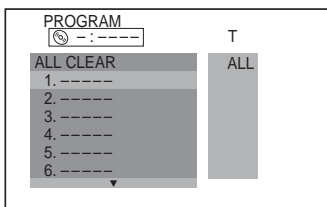

5 Select the disc you want to program using the number buttons or \uparrow/\downarrow , then press ENTER.

The cursor moves to the title or track row "T" (in this case, "01").

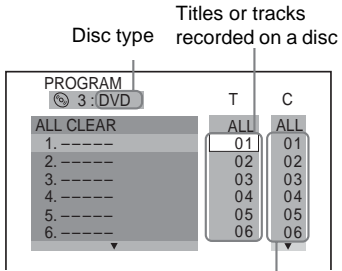

Chapters recorded on a disc

"?" appears when the player has not played the disc.

6 Select the title, chapter, or track you want to program.

◆ When playing a DVD VIDEO

For example, select chapter "03" of title "02."

Press \uparrow/\downarrow or the number buttons to select "02" under "T," then press ENTER.

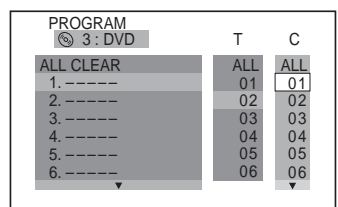

Next, press \uparrow/\downarrow or the number buttons to select "03" under "C," then press ENTER.

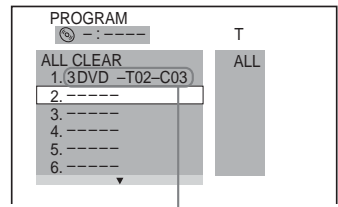

Selected disc, title and chapter

◆ When playing a VIDEO CD or CD

For example, select track "02."

Press \uparrow/\downarrow or the number buttons to select "02" under "T," then press ENTER.

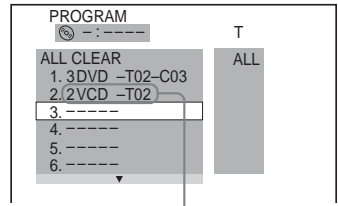

Selected disc and track

- 7** To program other discs, titles, chapters, or tracks, repeat Steps 3 to 6.

The programmed discs, titles, chapters, and tracks are displayed in the selected order.

- 8** Press \triangleright to start Program Play.

Program Play begins.

When the program ends, you can restart the same program again by pressing \triangleright .

To stop Program Play

Press CLEAR.

To turn off the display

Press DISPLAY repeatedly until the display is turned off.

To cancel or change a program

- 1 Follow Steps 1 to 3 of “Creating your own program (Program Play).”
- 2 Select the program number of the disc, title, chapter, or track you want to cancel or change using \uparrow/\downarrow or the number buttons, and press \rightarrow .
- 3 To cancel the program, press \leftarrow then CLEAR.
To change the program, follow Step 4 for new programming.

To cancel all the discs, titles, chapters, or tracks in the program

- 1 Follow Steps 1 and 2 of “Creating your own program (Program Play).”
- 2 Press \uparrow and select “ALL CLEAR.”
- 3 Press ENTER.

Hint

You can do Repeat Play or Shuffle Play of the programmed titles, chapters, or tracks. During Program Play, follow the steps of “Repeat Play” (page 41) or “Shuffle Play” (page 40).

Note

You cannot use this function with DATA CDs and DVD-RWs in VR mode.

Playing in random order (Shuffle Play)

DVD-V DVD-RW VCD CD DATA CD

You can have the player “shuffle” titles, chapters, or tracks. Subsequent “shuffling” may produce a different playing order. By selecting All Discs mode (page 38), you can shuffle all of the discs in the player.

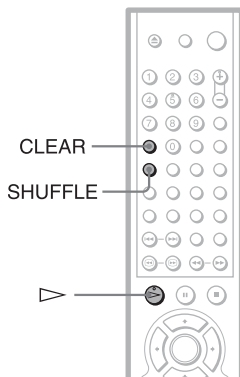

- 1** Press SHUFFLE during playback.

The following display appears.

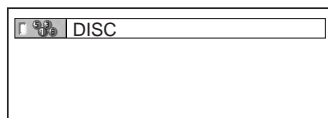

- 2** Press SHUFFLE repeatedly to select the item to be shuffled.

- ◆ When playing a DVD VIDEO
 - DISC*
 - TITLE
 - CHAPTER
- ◆ When playing a VIDEO CD or CD
 - DISC*
 - TRACK
- ◆ When playing a DVD-RW or DATA CD
 - DISC*
- ◆ When Program Play is activated
 - ON: shuffles titles, chapters, or tracks selected in Program Play.

* You can select “DISC” in All Discs mode only.

To return to normal play

Press CLEAR, or select “OFF” in Step 2.

Hints

- You can set Shuffle Play while the player is stopped. After selecting the “SHUFFLE” option, press . Shuffle Play starts.
- Up to 96 chapters in a disc can be played in random order when “CHAPTER” is selected.
- You can also select “SHUFFLE” from the Control Menu (page 12).

Playing repeatedly (Repeat Play)

DVD-V DVD-AW VCD CD DATA CD

You can play all of the titles, albums or tracks on a disc or a single title, chapter, album, or track repeatedly.

You can use a combination of Shuffle or Program Play modes. By selecting All Discs mode (page 38), you can repeat all of the discs in the player.

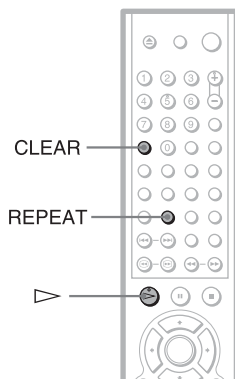

- 1** Press REPEAT during playback.
The following display appears.

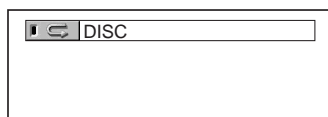

- 2** Press REPEAT repeatedly to select the item to be repeated.

◆ When playing a DVD VIDEO

- **DISC:** repeats all of the titles on the current disc in One Disc mode, or all of the discs in All Discs mode.
- **TITLE:** repeats the current title on a disc.
- **CHAPTER:** repeats the current chapter.

◆ When playing a DVD-RW

- DISC: repeats all of the titles on the selected type in One Disc mode, or all of the discs in All Discs mode.
- TITLE: repeats the current title on a disc.
- CHAPTER: repeats the current chapter.

◆ When playing a VIDEO CD or CD

- DISC: repeats all of the tracks on the current disc in One Disc mode, or all of the discs in All Discs mode.
- TRACK: repeats the current track.

◆ When playing a DATA CD (MP3 audio)

- DISC: repeats all of the albums on the current disc in One Disc mode, or all of the discs in All Discs mode.
- ALBUM: repeats the current album.
- TRACK: repeats the current track.

◆ When Program Play or Shuffle Play is activated

- ON: repeats Program Play or Shuffle Play.

To return to normal play

Press CLEAR, or select "OFF" in Step 2.

💡 Hints

- You can set Repeat Play while the player is stopped. After selecting the "REPEAT" option, press \triangleright . Repeat Play starts.
- You can also select "REPEAT" from the Control Menu (page 12).

Repeating a specific portion (A-B Repeat Play) **DVD-V** **DVD-RW** **VCD**

CD

You can play a specific portion of a title, chapter or track repeatedly. (This function is useful when you want to memorize lyrics, etc.)

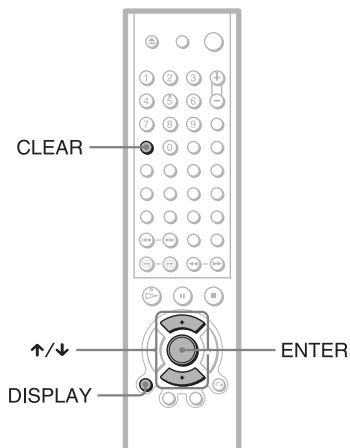

- 1 Press DISPLAY twice during playback (when playing a CD, press once).

The Control Menu appears.

- 2 Press ↑/↓ to select **A-B** (A-B REPEAT), then press ENTER.

The options for "A-B REPEAT" appear.

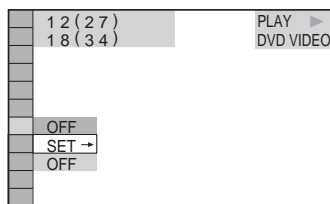

- 3 Press ↑/↓ to select "SET →," then press ENTER.

The "A-B REPEAT" setting display appears.

- A-B Repeat Play does not work across multiple titles (“ORIGINAL” or “PLAY LIST”) on a DVD-RW in VR mode.

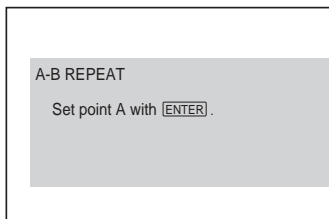

4 During playback, when you find the starting point (point A) of the portion to be played repeatedly, press ENTER.

The starting point (point A) is set.

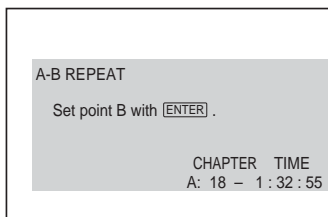

5 When you reach the ending point (point B), press ENTER again.

The set points are displayed and the player starts repeating this specific portion.

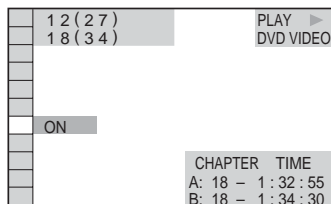

To return to normal play

Press CLEAR.

To turn off the Control Menu

Press DISPLAY repeatedly until the Control Menu is turned off.

Notes

- When you set A-B Repeat Play, the settings for Shuffle Play, Repeat Play, and Program Play are canceled.
- A-B Repeat Play does not work for titles containing still pictures on a DVD-RW in VR mode.

Searching for a Scene

Searching for a Title/ Chapter/Track/Index/ Scene (Search mode) **DVD-V**

DVD-RW **VCD** **CD** **DATA CD**

You can search a DVD by title or chapter, and you can search a VIDEO CD/CD by track, index, or scene. As titles and tracks are assigned unique numbers on the disc, you can select the desired one by entering its number. Or, you can search for a scene using the time code.

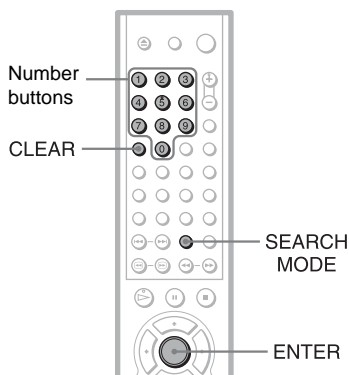

1 Press SEARCH MODE.

The following display appears.
“-- (**)” appears next to the icon (** refers to a number).

The number in parentheses indicates the total number of titles, tracks, indexes, scenes, etc. of the disc.

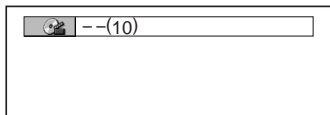

2 Press SEARCH MODE repeatedly to select the search method.

- ◆ When playing a DVD VIDEO/DVD-RW (TITLE)
- ◆ (CHAPTER)
- ◆ (TIME/TEXT)

Select “TIME/TEXT” to search for a starting point by inputting the time code.

- ◆ When playing a VIDEO CD (TRACK)
- ◆ (INDEX)

◆ When playing a VIDEO CD with PBC Playback

- ◆ (SCENE) or
- ◆ (INDEX)

- ◆ When playing a CD (TRACK)
- ◆ (INDEX)

- ◆ When playing a DATA CD (MP3 audio) (ALBUM)
- ◆ (TRACK)

3 Select the number of the title, track, scene, time code, etc. you want using the number buttons.

For example, to find the scene at 2 hours, 10 minutes, and 20 seconds after the beginning, select “TIME/TEXT” in Step 2 and enter “2:10:20.”

If you make a mistake

Cancel the number by pressing CLEAR, then select another number.

4 Press ENTER.

The player starts playback from the selected number.

To turn off the display

Press SEARCH MODE repeatedly until the display is turned off.

💡 Hints

- You can display the first scene of titles, chapters or tracks recorded on the disc on a screen divided into 9 sections. You can start playback directly by selecting one of the scenes. For details, see “Searching by Scene (PICTURE NAVIGATION)” (page 45).

- You can also select “TITLE,” “CHAPTER,” “TRACK,” “INDEX,” “SCENE,” “TIME/TEXT,” “ALBUM,” or “DISC” from the Control Menu (page 12).

Note

You cannot search for a still picture on a DVD-RW in VR mode.

Searching by Scene

(PICTURE NAVIGATION)

You can divide the screen into 9 subscreens and find the desired scene quickly.

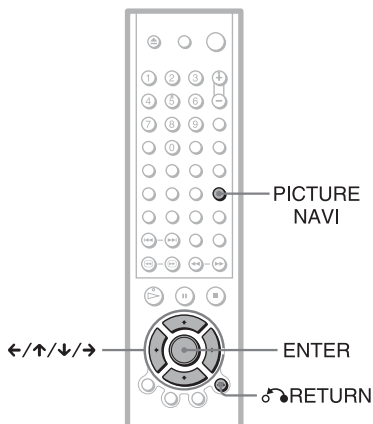

- 1 Press **PICTURE NAVI** during playback.

The following display appears.

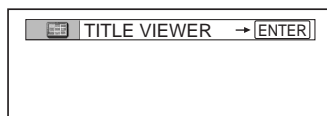

- 2 Press **PICTURE NAVI** repeatedly to select the item.

Refer to the explanations given for each item in the following sections.

- TITLE VIEWER (for DVD VIDEO only)
- CHAPTER VIEWER (for DVD VIDEO only)
- TRACK VIEWER (for VIDEO CD only)
- STROBE PLAYBACK
- ANGLE VIEWER (for DVD VIDEO only)

- 3 Press **ENTER**.

To return to normal play

Press **↶** RETURN.

Hint

You can also select "PICTURE NAVIGATION" from the Control Menu (page 12).

Notes

- Depending on the disc, you may not be able to select all functions.
- The sound is muted when using this function.

Scanning the title, chapter, or track (TITLE VIEWER, CHAPTER VIEWER, TRACK VIEWER)

DVD-V **VCD**

You can divide the screen into 9 subscreens and display the first scene of titles, chapters, or tracks.

You can also play back from the selected title, chapter, or track. After performing Step 3 of "Searching by Scene" above, select the scene using **←/↑/↓/→** and press ENTER.

Hint

If there are more than 9 titles, chapters, or tracks, ▼ is displayed at the bottom right.

To display the additional titles, chapters, or tracks, select the bottom right scene (the position 9) and press **↓**. To return to the previous scene, select the top left scene (the position 1) and press **↑**.

1	2	3
4	5	6
7	8	9

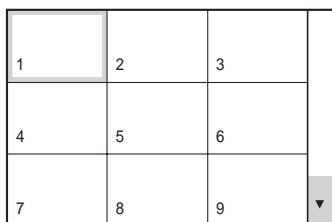

Dividing a scene into 9 sections (STROBE PLAYBACK) **DVD-V** **VCD**

You can display 9 consecutive moving pictures on the screen.

When you press **||** after performing Step 3 of "Searching by Scene" above, the moving pictures pause.

Displaying different angles simultaneously (ANGLE VIEWER)

DVD-V

If various angles (multi-angles) for a scene are recorded on the DVD VIDEO, you can display all of the angles recorded on the disc on the screen divided into 9 sections.

You can also play back from the selected angle. After performing Step 3 of "Searching by Scene" above, select the angle using **←/↑/↓/→** and press ENTER.

Checking the Playing Time and Remaining Time

Time **DVD-V** **DVD-RW** **VCD** **CD**

DATA CD

You can check the playing time and remaining time of the current title, chapter, or track. Also, you can check the DVD/CD text or track name (MP3 audio) recorded on the disc.

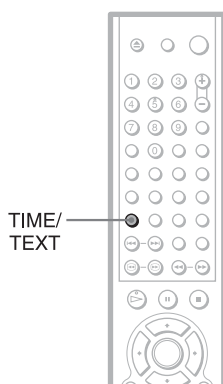

1 Press TIME/TEXT during playback.

The following display appears.

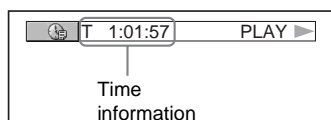

2 Press TIME/TEXT repeatedly to change the time information.

The display and the kinds of time that you can change depend on the disc you are playing.

◆ When playing a DVD VIDEO or DVD-RW

- T **: **: **
Playing time of the current title
- T- **: **: **
Remaining time of the current title
- C **: **: **
Playing time of the current chapter
- C- **: **: **
Remaining time of the current chapter

◆ When playing a VIDEO CD (with PBC functions)

- **: **: **
Playing time of the current scene

◆ When playing a VIDEO CD (without PBC functions) or CD

- T **: **: **
Playing time of the current track
- T- **: **: **
Remaining time of the current track
- D **: **: **
Playing time of the current disc
- D- **: **: **
Remaining time of the current disc

◆ When playing a DATA CD (MP3 audio)

- **: **: **: **
Playing time of the current track

To check the DVD/CD text or track and album names (MP3 audio)

Press TIME/TEXT repeatedly in Step 2 to display text recorded on the DVD VIDEO/CD/DATA CD.

The DVD/CD text appears only when text is recorded in the disc. You cannot change the text. If the disc does not contain text, "NO TEXT" appears.



For DATA CDs, the track and album names of the MP3 audio track appears (page 50).

Checking the information on the front panel display

You can view the time information and text displayed on the TV screen also on the front panel display. The information on the front panel display changes as follows when you change the time information on your TV screen.

When playing a DVD VIDEO or DVD-RW

Title playing time and current disc, title and chapter number

DISC	TITLE	CHAP	HOUR	MIN	SEC
1.	1.	2	1:	03	24

Remaining time of the current title

DISC	TITLE	CHAP	HOUR	MIN	SEC
1.	1.	2	-1:	15	36

Playing time and number of the current chapter

DISC	CHAP	HOUR	MIN	SEC
1.	2	0:	22	30

Remaining time of the current chapter

DISC	CHAP	HOUR	MIN	SEC
1.	2	-0:	13	20

Text

SONY HITS/5

When playing a VIDEO CD (without PBC functions) or CD

Track playing time and current disc, track and index number

DISC	TRACK	INDEX	MIN	SEC
1.	2	1	2	25

Remaining time of the current track

DISC	TRACK	INDEX	MIN	SEC
1.	2	1	-1	50

Playing time of the disc

DISC	MIN	SEC
1.	32	12

Remaining time of the disc

DISC	MIN	SEC
1.	-20	18

Text

SONY HITS/5

When playing a DATA CD (MP3 audio)

Track playing time and number of the current disc, album and track

DISC	ALBUM	TRACK	MIN	SEC
4	50	21	17	30

Track name

DIHAPPY BIRTH

Hints

- When playing VIDEO CDs with PBC functions, the disc number, scene number and the playing time are displayed.
- Long text that does not fit in a single line will scroll across the front panel display.
- You can also check the time information and text using the Control Menu (page 12).

Notes

- Depending on the type of disc being played, the DVD/CD text or track name may not be displayed.
- The player can only display the first level of the DVD/CD text, such as the disc name or title.
- Playing time of MP3 audio tracks may not be displayed correctly.

Checking the Play Information

You can check information such as the bit rate or the disc layer that is being played.

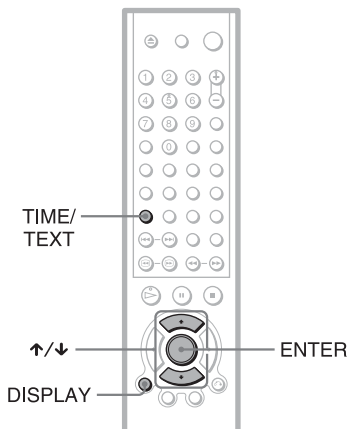

Checking the play information of DVD (ADVANCED) **DVD-V** **DVD-RW**

- 1 Press **DISPLAY** during playback.
The Control Menu is displayed.
- 2 Press **↑/↓** to select  (ADVANCED), then press **ENTER**.
The options for “ADVANCED” appear.

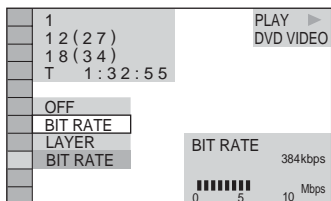

- 3 Press **↑/↓** to select items.
For each item, please refer to “Displays of each item.”
 - **BIT RATE**: displays the bit rate.
 - **LAYER**: displays the layer and the pick-up point.
- 4 Press **ENTER**.

To close the **ADVANCED** window
Select “OFF” in Step 3.

To turn off the **Control Menu**
Press **DISPLAY** repeatedly until the Control Menu is turned off.

Display of each item
By pressing **DISPLAY** repeatedly, you can display either “**BIT RATE**” or “**LAYER**,” whichever was selected in “**ADVANCED**.”

◆ **BIT RATE**

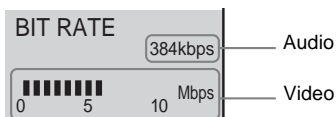

Bit rate refers to the amount of video/audio data per second in a disc. While playing a disc, an approximate bit rate of the playback picture is displayed as Mbps (Mega bit per second) and the audio as kbps (kilo bit per second). The higher the bit rate, the larger the amount of data. However, this does not always mean that you can get higher quality pictures or sounds.

◆ **LAYER**

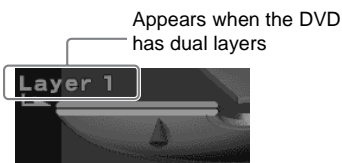

Indicates the approximate point where the disc is playing.
If it is a dual-layer DVD, the player indicates which layer is being read (“Layer 0” or “Layer 1”).
For details on the layers, see page 78 (DVD VIDEO).

Checking the play information of DATA CD

By pressing TIME/TEXT while playing MP3 audio track on a DATA CD, you can display the audio bit rate (the amount of data per second of the current audio).

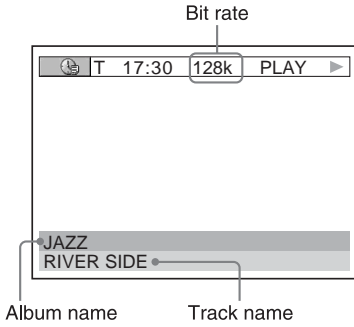

Sound Adjustments

Changing the Sound

DVD-V DVD-RW VCD CD

DATA CD

When playing a DVD recorded in multiple audio formats (PCM, Dolby Digital, MPEG audio, or DTS), you can change the audio format. If the DVD is recorded with multilingual tracks, you can also change the language.

With CDs, DATA CDs, or VIDEO CDs, you can select the sound from the right or left channel and listen to the sound of the selected channel through both the right and left speakers. For example, when playing a disc containing a song with the vocals on the right channel and the instruments on the left channel, you can hear the instruments from both speakers by selecting the left channel.

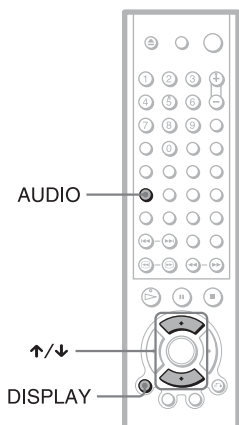

1 Press AUDIO during playback.

The following display appears.

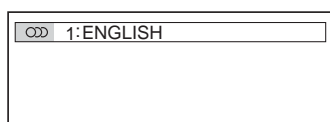

2 Press AUDIO repeatedly to select the desired audio signal.

◆ When playing a DVD VIDEO

Depending on the DVD VIDEO, the choice of language varies.

When 4 digits are displayed, they indicate a language code. Refer to "Language Code List" on page 81 to see which language the code represents. When the same language is displayed two or more times, the DVD VIDEO is recorded in multiple audio formats.

◆ When playing a DVD-RW

The types of sound tracks recorded on a disc are displayed. The default setting is underlined.

Example:

- 1: MAIN (main sound)
- 1: SUB (sub sound)
- 1: MAIN+SUB (main and sub sound)

◆ When playing a VIDEO CD, CD, or DATA CD (MP3 audio)

The default setting is underlined.

- STEREO: The standard stereo sound
- 1/L: The sound of the left channel (monaural)
- 2/R: The sound of the right channel (monaural)

💡 Hints

You can also select "AUDIO" from the Control Menu (page 12).

Displaying the audio information of the disc DVD-V

Press DISPLAY during playback to display the Control Menu. Select "AUDIO" using **↑/↓**. The channels being played are displayed on the screen.

For example, in Dolby Digital format, multiple signals ranging from monaural to 1.1 channel signals can be recorded on a DVD VIDEO. Depending on the DVD VIDEO, the number of the recorded channels may differ.

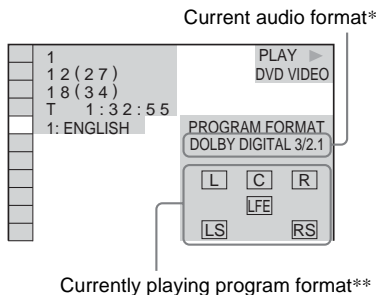

**“PCM,” “DTS,” or “DOLBY DIGITAL” is displayed.

In the case of “DOLBY DIGITAL,” the channels in the playing track are displayed by numbers as follows:

For Dolby Digital 5.1 ch:

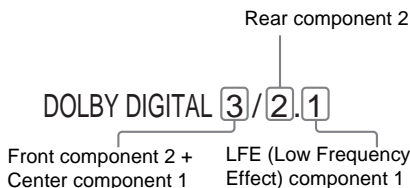

**The letters in the program format display mean the following sound component:

- L: Front (left)
- R: Front (right)
- C: Center
- LS: Rear (left)
- RS: Rear (right)
- S: Rear (monaural): The rear component of the Dolby Surround processed signal and the Dolby Digital signal
- LFE: Low Frequency Effect signal

Hint

For Dolby Digital and DTS, “LFE” is always enclosed in a solid line regardless of the LFE signal component being output.

Note

If “DTS” is set to “OFF” in “AUDIO SETUP” (page 73), the DTS track selection option will not appear on the screen even if the disc contains DTS tracks.

TV Virtual Surround Settings (TVS) **DVD-V**

When you connect a stereo TV or 2 front speakers, TVS (TV Virtual Surround) lets you enjoy surround sound effects by using sound imaging to create virtual rear speakers from the sound of the front speakers (L: left, R: right) without using actual rear speakers. TVS was developed by Sony to produce surround sound for home use using just a stereo TV.

This function is designed to work with the LINE OUT L/R (AUDIO) 1/2 jacks.

Note that if you select one of the TVS settings, the player does not output the following signals from the DIGITAL OUT (COAXIAL or OPTICAL) jack.

—Dolby Digital signals when you set “DOLBY DIGITAL” in “AUDIO SETUP” to “D-PCM” (page 73)

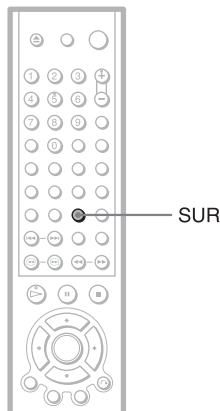

1 Press SUR during playback.

The following display appears.

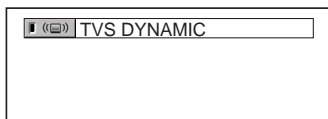

2 Press SUR repeatedly to select one of the TVS sounds.

Refer to the following explanations given for each item.

- TVS DYNAMIC
- TVS WIDE
- TVS NIGHT
- TVS STANDARD

To cancel the setting

Select “OFF” in Step 2.

◆TVS DYNAMIC

Creates virtual rear speakers from the sound of the front speakers (L, R) without using actual rear speakers (shown below).

This mode is effective when the distance between the front L and R speakers is short, such as with built-in speakers on a stereo TV.

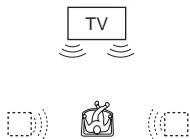

◆TVS WIDE

Creates virtual rear speakers from the sound of the front speakers (L, R) without using actual rear speakers. The virtual speakers are reproduced as shown in the illustration below.

This mode is effective when the distance between the front L and R speakers is short, such as with built-in speakers on a stereo TV.

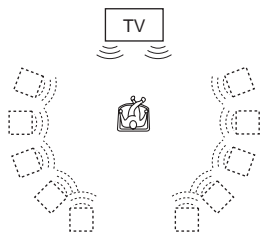

◆TVS NIGHT

Large sounds, such as explosions, are suppressed, but the quieter sounds are unaffected. This feature is useful when you want to hear the dialog and enjoy the surround sound effects of “TVS WIDE” at low volume.

◆TVS STANDARD

Creates virtual rear speakers from the sound of the front speakers (L, R) without using actual rear speakers. The virtual speakers are reproduced as shown in the illustration below. Use this setting when you want to use TVS with 2 separate speakers.

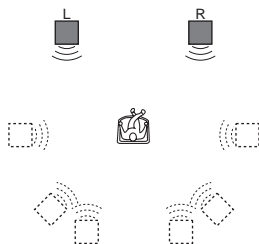

L : Front speaker (left)
R : Front speaker (right)
□ : Virtual speaker

💡 Hints

- You can also select “TVS” by pressing the SURROUND button on the player.
- You can also select “TVS” from the Control Menu (page 12).

Notes

- When the playing signal does not contain a signal for the rear speakers, the surround effects cannot be heard.
- When you select one of the TVS modes, turn off the surround setting of the connected TV or amplifier (receiver).
- Make sure that your listening position is between and at an equal distance from your speakers, and that the speakers are located in similar surroundings.
- “TVS NIGHT” only works with Dolby Digital discs. However, not all discs will respond to the “TVS NIGHT” function in the same way.
- If you use the DIGITAL OUT (COAXIAL or OPTICAL) jack and set “DOLBY DIGITAL” to “ON” in “AUDIO SETUP,” sound will come from your speakers but it will not have the TVS effect.

Note

Depending on the DVD VIDEO, you may not be able to change the angles even if multi-angles are recorded on the DVD VIDEO.

Changing the Angles

DVD-V

If various angles (multi-angles) for a scene are recorded on the DVD VIDEO, "ANGLE" appears in the front panel display. This means that you can change the viewing angle.

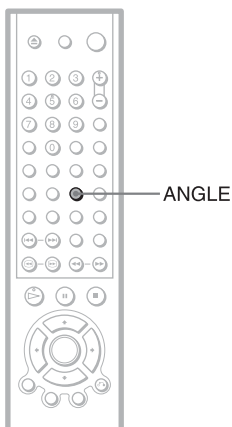

1 Press ANGLE during playback.

The number of the angle appears on the display.

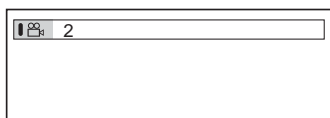

2 Press ANGLE repeatedly to select the angle number.

The scene changes to the selected angle.

Hints

- You can display all the angles recorded on the disc on the same screen, and start playback directly from the chosen angle. The angles are displayed on a screen divided into 9 sections. For details, see page 45.
- You can also select "ANGLE" from the Control Menu (page 12).

Displaying the Subtitles

DVD-V **DVD-RW**

If subtitles are recorded on the discs, you can change the subtitles or turn them on and off whenever you want while playing a DVD.

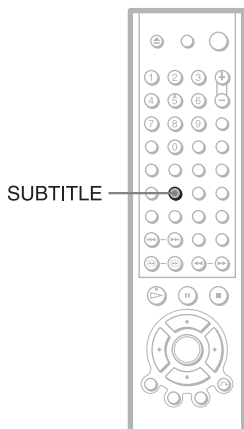

1 Press SUBTITLE during playback.

The following display appears.

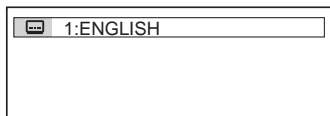

2 Press SUBTITLE repeatedly to select the language.

◆ **When playing a DVD VIDEO**
Select the language.
Depending on the DVD VIDEO, the choice of language varies.
When 4 digits are displayed, they indicate a language code. Refer to “Language Code List” on page 81 to see which language the code represents.

◆ **When playing a DVD-RW**
Select “ON.”

To turn off the subtitles

Select “OFF” in Step 2.

Hint

You can also select “SUBTITLE” from the Control Menu (page 12).

Note

Depending on the DVD VIDEO, you may not be able to change the subtitles even if multilingual subtitles are recorded on it. You also may not be able to turn them off.

Adjusting the Picture Quality (BNR) **DVD-V** **DVD-RW**

VCD

The Block Noise Reduction (BNR) function adjusts the picture quality by reducing the “block noise” or mosaic like patterns that appear on your TV screen.

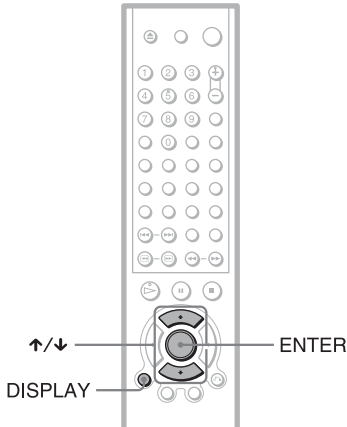

1 Press **DISPLAY** twice during playback.

The Control Menu appear.

2 Press **↑/↓** to select **BNR**, then press **ENTER**.

The options for “BNR” appears.

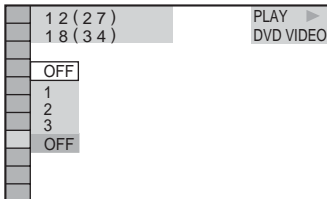

3 Press **↑/↓** to select a level.

- 1: reduces the “block noise.”
- 2: reduces the “block noise” more than 1.
- 3: reduces the “block noise” more than 2.

4 Press **ENTER**.

The disc plays with the setting you selected.

To cancel the “BNR” setting

Select “OFF” in Step 3.

To turn off the Control Menu

Press **DISPLAY** repeatedly until the Control Menu is turned off.

Notes

- If the outlines of the images on your screen should become blurred, set “BNR” to “OFF.”
- Depending on the disc or the scene being played, the “BNR” effect may be hard to discern.

Adjusting the Playback Picture (CUSTOM PICTURE MODE)

DVD-V DVD-RW VCD

You can adjust the video signal of the DVD or VIDEO CD from the player to obtain the picture quality you want. Choose the setting that best suits the program you are watching. When you select “MEMORY,” you can make further adjustments to each element of the picture (color, brightness, etc.).

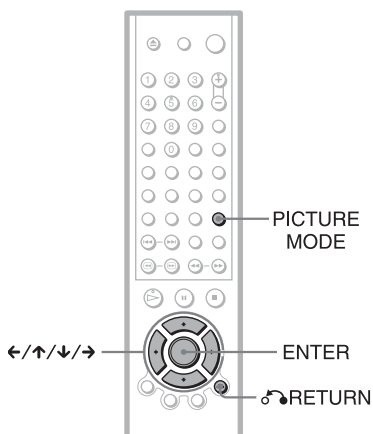

1 Press PICTURE MODE during playback.

The following display appears.

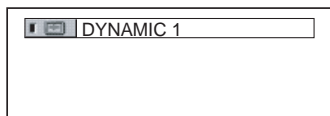

2 Press PICTURE MODE repeatedly to select the setting you want.

The default setting is underlined.

- STANDARD: displays a standard picture.
- DYNAMIC 1: produces a bold dynamic picture by increasing the picture contrast and the color intensity.
- DYNAMIC 2: produces a more dynamic picture than DYNAMIC 1 by further increasing the picture contrast and the color intensity.
- CINEMA 1: enhances details in dark areas by increasing the black level.
- CINEMA 2: White colors become brighter and black colors become richer, and the color contrast is increased.
- MEMORY: adjusts the picture in greater detail.

💡 Hints

- When you watch a movie, “CINEMA 1” or “CINEMA 2” is recommended.
- The picture can be adjusted by pressing the PICTURE MODE button on the player as well.
- You can also select the “CUSTOM PICTURE MODE” from the Control Menu (page 12).

Adjusting the picture items in “MEMORY”

You can adjust each element of the picture individually.

- PICTURE: changes the contrast
- BRIGHTNESS: changes the overall brightness
- COLOR: makes the colors deeper or lighter
- HUE: changes the color balance

1 Press PICTURE MODE repeatedly to select “MEMORY” and press ENTER.

The “PICTURE” adjustment bar appears.



- 2 Press \leftarrow/\rightarrow to adjust the picture contrast, then press ENTER.

The adjustment is saved, and “BRIGHTNESS” adjustment bar appears.

- 3 Repeat Step 2 to adjust “BRIGHTNESS,” “COLOR,” and “HUE.”

The Custom Picture Mode display appears. You can check each adjustment.

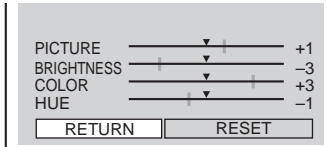

To turn off the display

Press \leftarrow/\rightarrow RETURN, or select “RETURN” in Step 3 and press ENTER.

🔧 Hints

- To reset the picture items to the default values, press \rightarrow after Step 3 to select “RESET” and press ENTER.
- When “PLAYBACK MEMORY” in “CUSTOM SETUP” is set to “ON,” the player will save a single setting for up to 40 individual discs. (This does not apply to DVD-RWs in VR mode.)
- If you do not want to save your adjustment in Step 2, you can go to the next picture item by pressing \uparrow/\downarrow without saving.

Enhancing the Playback Picture (DIGITAL VIDEO

ENHANCER) **DVD-V** **DVD-RW** **VCD**

The Digital Video Enhancer (DVE) function makes the picture appear clear and crisp by enhancing the outlines of images on your TV screen. Also, this function can soften the images on the screen.

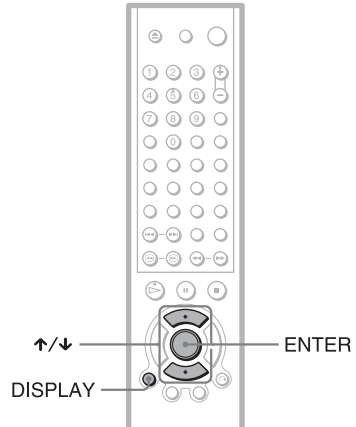

- 1 Press DISPLAY twice during playback.

The Control Menu appears.

- 2 Press \uparrow/\downarrow to select  (DIGITAL VIDEO ENHANCER), then press ENTER.

The options for “DIGITAL VIDEO ENHANCER” appear.

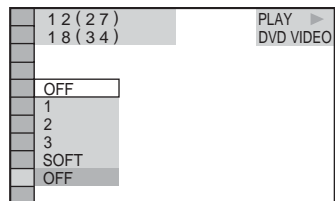

- 3 Press \uparrow/\downarrow to select a level.

- 1: enhances the outline.
- 2: enhances the outline more than 1.

- 3: enhances the outline more than 2.
- SOFT: softens the image (DVD VIDEO/DVD-RW only)

4 Press ENTER.

The disc plays with the setting you selected.

To cancel the “DIGITAL VIDEO ENHANCER” setting

Select “OFF” in Step 3.

To turn off the Control Menu

Press DISPLAY repeatedly until the Control Menu is turned off.

Note

Depending on the disc or the scene being played, noise found in the disc may become more apparent. If this happens, it is recommended that you use the BNR function (page 56) with the DVE function. If the condition still does not improve, reduce the Digital Video Enhancer level, or select “SOFT” (DVD VIDEO/DVD-RW only) in Step 3 above.

Using Various Additional Functions

Locking Discs (CUSTOM PARENTAL CONTROL, PARENTAL CONTROL)

You can set two kinds of playback restrictions for the desired disc.

- Custom Parental Control
You can set playback restrictions so that the player will not play inappropriate discs.
- Parental Control
Playback of some DVD VIDEOS can be limited according to a predetermined level such as the age of the users. Scenes may be blocked or replaced with different scenes. The same password is used for both Parental Control and Custom Parental Control.

Custom Parental Control

DVD-V VCD CD

You can set the same Custom Parental Control password for up to 40 discs. When you set the 41st-disc, the first disc is canceled.

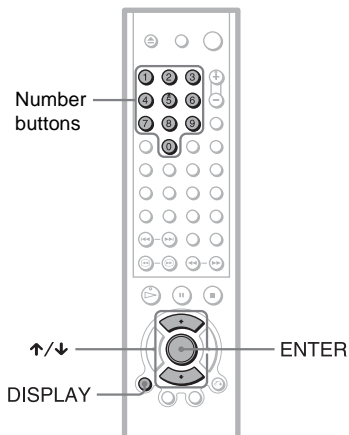

- 1 Insert the disc you want to lock.
If the disc is playing, press **■** to stop playback.

- 2 Press **DISPLAY** while the player is in stop mode.
The Control Menu appears.
- 3 Press **↑/↓** to select  (PARENTAL CONTROL), then press **ENTER**.
The options for "PARENTAL CONTROL" appear.

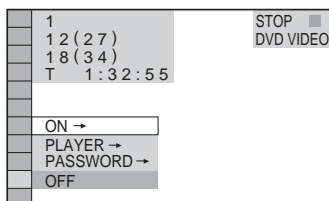

- 4 Press **↑/↓** to select "ON →," then press **ENTER**.
◆ If you have not entered a password
The display for registering a new password appears.

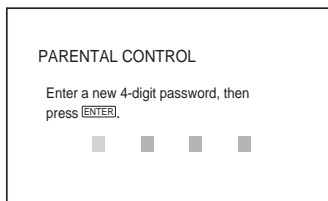

Enter a 4-digit password using the number buttons, then press **ENTER**.
The display for confirming the password appears.

- ◆ When you have already registered a password
The display for entering the password appears.

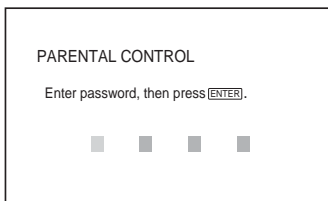

- 5 Enter or re-enter your 4-digit password using the number buttons, then press ENTER.

“Custom parental control is set.” appears and the screen returns to the Control Menu.

To turn off the Custom Parental Control function

- 1 Follow Steps 1 through 3 of “Custom Parental Control.”
- 2 Press \uparrow/\downarrow to select “OFF \rightarrow ,” then press ENTER.
- 3 Enter your 4-digit password using the number buttons, then press ENTER.

To play a disc for which Custom Parental Control is set

- 1 Insert the disc for which Custom Parental Control is set. The “CUSTOM PARENTAL CONTROL” display appears.

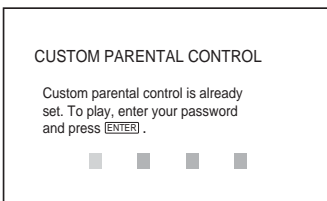

- 2 Enter your 4-digit password using the number buttons, then press ENTER. The player is ready for playback.

Hint

If you forget your password, enter the 6-digit number “199703” using the number buttons when the “CUSTOM PARENTAL CONTROL” display asks you for your password, then press ENTER. The display will ask you to enter a new 4-digit password.

Parental Control (limited playback) **DVD-V**

Playback of some DVD VIDEOS can be limited according to a predetermined level such as the age of the users. The “PARENTAL CONTROL” function allows you to set a playback limitation level.

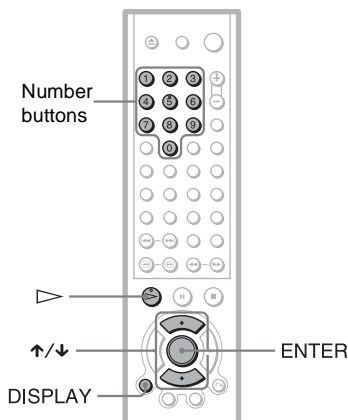

- 1 Press DISPLAY while the player is in stop mode. The Control Menu appears.
- 2 Press \uparrow/\downarrow to select (PARENTAL CONTROL), then press ENTER. The options for “PARENTAL CONTROL” appear.

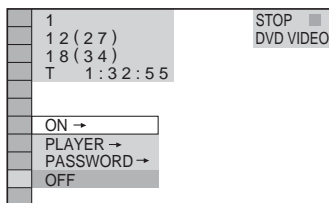

3 Press \uparrow/\downarrow to select "PLAYER \rightarrow ," then press ENTER.

◆ **If you have not entered a password**

The display for registering a new password appears.

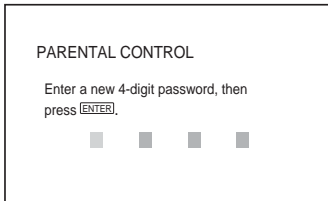

Enter a 4-digit password using the number buttons, then press ENTER. The display for confirming the password appears.

◆ **When you have already registered a password**

The display for entering the password appears.

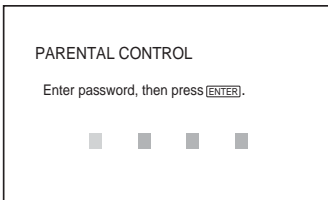

4 Enter or re-enter your 4-digit password using the number buttons, then press ENTER.

The display for setting the playback limitation level appears.

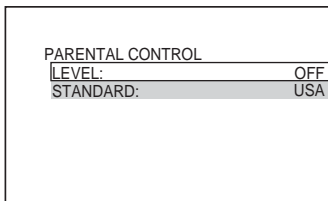

5 Press \uparrow/\downarrow to select "STANDARD," then press ENTER.

The selection items for "STANDARD" are displayed.

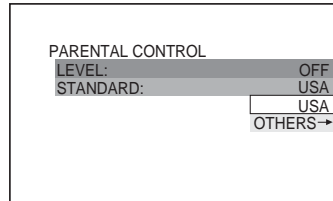

6 Press \uparrow/\downarrow to select a geographic area as the playback limitation level, then press ENTER.

The area is selected.

When you select "OTHERS \rightarrow ," select and enter a standard code in the table on page 63.

7 Press \uparrow/\downarrow to select "LEVEL," then press ENTER.

The selection items for "LEVEL" are displayed.

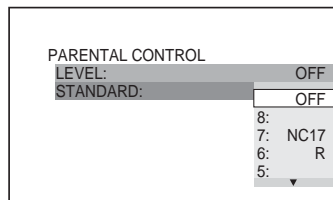

8 Select the level you want using \uparrow/\downarrow , then press ENTER.

Parental Control setting is complete.

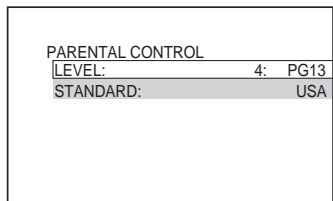

The lower the value, the stricter the limitation.

To turn off the Parental Control function
Set "LEVEL" to "OFF" in Step 8.

To play a disc for which Parental Control is set

- 1 Insert the disc and press \triangleright .
The display for entering your password appears.
- 2 Enter your 4-digit password using the number buttons, then press ENTER.
The player starts playback.

Hint

If you forget your password, remove the disc and repeat Steps 1 to 3 of "Parental Control (limited playback)." When you are asked to enter your password, enter "199703" using the number buttons, then press ENTER. The display will ask you to enter a new 4-digit password. After you enter a new 4-digit password, replace the disc in the player and press \triangleright . When the display for entering your password appears, enter your new password.

Notes

- When you play discs which do not have the Parental Control function, playback cannot be limited on this player.
- Depending on the disc, you may be asked to change the parental control level while playing the disc. In this case, enter your password, then change the level. If the Resume Play mode is cancelled, the level returns to the previous level.

Area Code

Standard	Code number	Standard	Code number
Argentina	2044	Malaysia	2363
Australia	2047	Mexico	2362
Austria	2046	Netherlands	2376
Belgium	2057	New Zealand	2390
Brazil	2070	Norway	2379
Canada	2079	Pakistan	2427
Chile	2090	Philippines	2424
China	2092	Portugal	2436
Denmark	2115	Russia	2489
Finland	2165	Singapore	2501
France	2174	Spain	2149
Germany	2109	Sweden	2499
India	2248	Switzerland	2086
Indonesia	2238	Thailand	2528
Italy	2254	United Kingdom	2184
Japan	2276		
Korea	2304		

Changing the password

- 1 Press DISPLAY while the player is in stop mode.
The Control Menu appears.
- 2 Press \uparrow/\downarrow to select  (PARENTAL CONTROL), then press ENTER.
The options for "PARENTAL CONTROL" appear.
- 3 Press \uparrow/\downarrow to select "PASSWORD \rightarrow ," then press ENTER.
The display for entering the password appears.
- 4 Enter your 4-digit password using the number buttons, then press ENTER.
- 5 Enter a new 4-digit password using the number buttons, then press ENTER.
- 6 To confirm your password, re-enter it using the number buttons, then press ENTER.

If you make a mistake entering your password

Press **←** before you press ENTER and input the correct number.

If you make a mistake

Press **↶** RETURN.

To turn off the display

Press DISPLAY repeatedly until the display is turned off.

Operation Sound Effects

(Sound Feedback)

The player beeps when the following operations are performed.

The default setting of the Sound Feedback function is set to off.

Operation	Operation sound
Power is turned on	One beep
Power is turned off	Two beeps
▷ is pressed	One beep
⏸ is pressed	Two beeps
Playback is stopped	One long beep
Operation is not possible	Three beeps

To set Sound Feedback

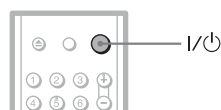
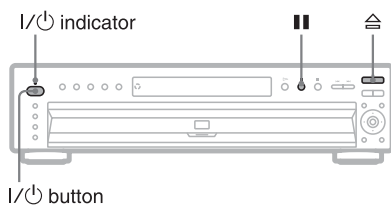

- 1 Press I/O on the player or the remote.**
The I/O indicator lights up in green.
If there is a disc in the player, press **⏻** and remove the disc.
- 2 Press and hold ⏸ on the player for more than two seconds.**
You will hear one beep and the Sound Feedback function is turned on.

To turn off the Sound Feedback function

When there is no disc in the player, press and hold **⏸** on the player for more than two seconds. You will hear two beeps and the Sound Feedback function is turned off.

Controlling Your TV or AV Amplifier (Receiver) with the Supplied Remote

By adjusting the remote signal, you can control your TV with the supplied remote. If you connect the player with an AV amplifier (receiver), you can control the volume with the supplied remote.

Notes

- Depending on the unit being connected, you may not be able to control your TV or AV amplifier (receiver) using some of the buttons below.
- If you enter a new code number, the code number previously entered will be erased.
- When you replace the batteries of the remote, the code number you have set may be reset to the default setting. Set the appropriate code number again.

Controlling TVs with the remote

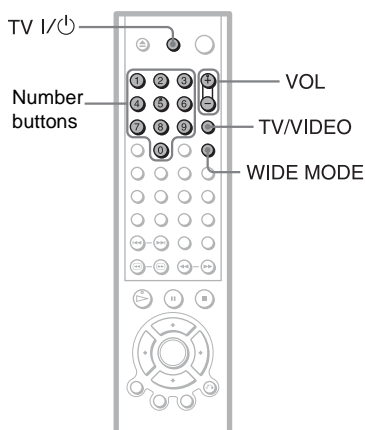

- 1 Hold down TV I/⏻, and enter your TV's manufacturer's code (see the table below) using the number buttons.
- 2 Release TV I/⏻.

Code numbers of controllable TVs

If more than one code number is listed, try entering them one at a time until you find the one that works with your TV.

Manufacturer	Code number	Manufacturer	Code number
Sony (default)	01	Philco	03,04
Akai	04	Philips	08,21
AOC	04	Pioneer	16
Centurion	12	Portland	03
Coronado	03	Proscan	10
Curtis-Mathes	12	Quasar	06,18
Daytron	12	Radio Shack	05,14
Emerson	03,04,14	RCA	04,10
Fisher	11	Sampo	12
General Electric	06,10	Samsung	20,3,12
Gold Star	03,04,17	Sanyo	11,14
Hitachi	02,03	Scott	12
J.C.Penney	04,12	Sears	07,10,11
JVC	09	Sharp	03,05,18
KMC	03	Sylvania	08,12
Magnavox	03,08,12	Teknika	03,08,14
Marantz	04,13	Toshiba	07
MGA/Mitsubishi	04,12,13,17	Wards	03,04,12
NEC	04,12	Yorx	12
Panasonic	06,19	Zenith	15

To control the TV

You can control the following items with the supplied remote.

By pressing	You can
TV I/⏻	Turn the TV on or off
VOL +/-*	Adjust the volume of the TV
WIDE MODE	Switch to or from the wide mode of a Sony's wide TV
TV/VIDEO	Switch the TV's input source between the TV and other input sources

* Once you set the code number for AV amplifier (receiver), VOL +/- buttons adjust the volume of AV amplifier. To adjust the volume of TV, set 90 (default) as the code of AV amplifier.

Controlling the volume of your AV amplifier (receiver) with the remote

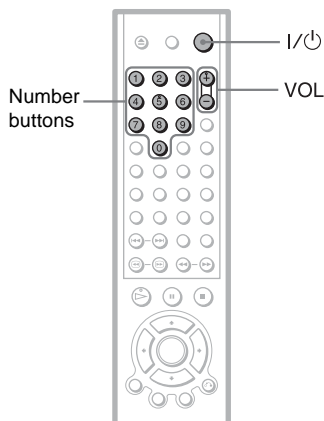

1 Hold down I/⏻, and enter your AV amplifier (receiver)'s manufacturer's code (see the table below) using the number buttons.

2 Release I/⏻.

You can control the volume of the AV amplifier (receiver) using VOL +/-.

Code numbers of controllable AV amplifiers (receivers)

If more than one code number is listed, try entering them one at a time until you find the one that works with your AV amplifier (receiver).

Manufacturer	Code number
Sony	80, 88, 89, 91
Denon	84, 85, 86
Kenwood	92, 93
Onkyo	81, 82, 83
Pioneer	99
Sansui	87
Technics	97, 98
Yamaha	94, 95, 96

If you do not control an AV amplifier (receiver)

You can control your TV's volume by setting the code number to 90 (default).

Using the Setup Display

By using the Setup Display, you can make various adjustments to items such as picture and sound. You can also set a language for the subtitles and the Setup Display, among other things. For details on each Setup Display item, see pages from 68 to 73.

Note

Playback settings stored in the disc take priority over the Setup Display settings and not all the functions described may work.

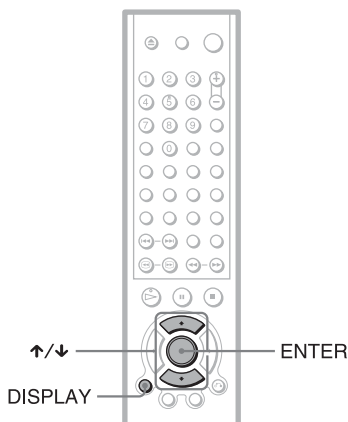

- 1 Press **DISPLAY** when the player is in stop mode.

The Control Menu appears.

- 2 Press **↑/↓** to select  (**SETUP**), then press **ENTER**.

The options for "SETUP" appear.

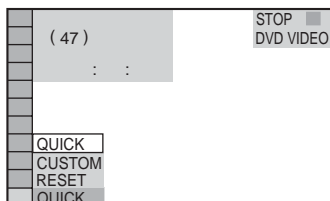

- 3 Press **↑/↓** to select "CUSTOM," then press **ENTER**.

The Setup Display appears.

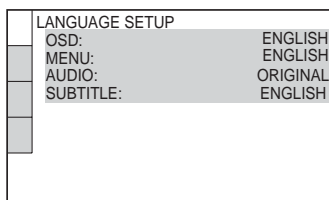

- 4 Press **↑/↓** to select the setup item from the displayed list:

"LANGUAGE SETUP," "SCREEN SETUP," "CUSTOM SETUP," or "AUDIO SETUP." Then press **ENTER**.

The Setup item is selected.

Example: "SCREEN SETUP"

Selected item

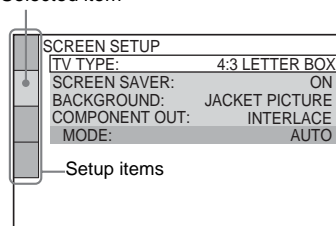

- 5 Select an item using **↑/↓**, then press **ENTER**.

The options for the selected item appear.

Example: "TV TYPE"

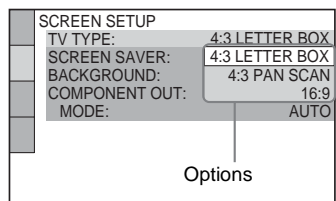

Options

6 Select a setting using \uparrow/\downarrow , then press ENTER.

The setting is selected and setup is complete.

Example: "16:9"

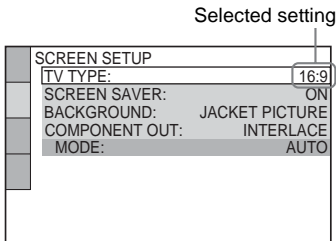

To turn off the display

Press DISPLAY repeatedly until the display is turned off.

To enter the Quick Setup mode

Select "QUICK" in Step 3. Follow from Step 5 of the Quick Setup explanation to make basic adjustments (page 25).

To reset all of the "SETUP" settings

- 1 Select "RESET" in Step 3 and press ENTER
- 2 Select "YES" using \uparrow/\downarrow .
- 3 Press ENTER.
All the settings explained on pages 68 to 73 return to the default settings. Do not press I/ψ while resetting the player as it takes a few seconds to complete.

Setting the Display or Sound Track Language

(LANGUAGE SETUP)

"LANGUAGE SETUP" allows you to set various languages for the on-screen display or sound track.

Select "LANGUAGE SETUP" in the Setup Display. To use the display, see "Using the Setup Display" (page 67).

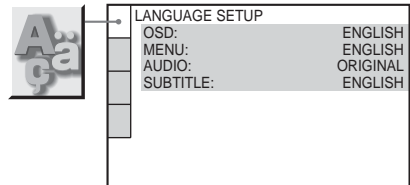

◆ OSD (On-Screen Display)

Switches the display language on the screen.

◆ MENU (DVD VIDEO only)

You can select the desired language for the disc's menu.

◆ AUDIO (DVD VIDEO only)

Switches the language of the sound track. When you select "ORIGINAL," the language given priority in the disc is selected.

◆ SUBTITLE (DVD VIDEO only)

Switches the language of the subtitle recorded on the DVD VIDEO.

When you select "AUDIO FOLLOW," the language for the subtitles changes according to the language you selected for the sound track.

🔔 Hint

If you select "OTHERS \rightarrow " in "MENU," "SUBTITLE," and "AUDIO," select and enter a language code from "Language Code List" on page 81 using the number buttons.

Note

When you select a language in "MENU," "SUBTITLE," or "AUDIO" that is not recorded on the DVD VIDEO, one of the recorded languages will be automatically selected.

Settings for the Display

(SCREEN SETUP)

Choose settings according to the TV to be connected.

Select "SCREEN SETUP" in the Setup Display. To use the display, see "Using the Setup Display" on page 67.

The default settings are underlined.

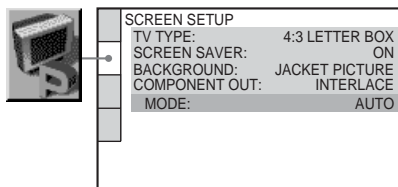

◆ TV TYPE

Selects the aspect ratio of the connected TV (4:3 standard or wide).

<u>4:3 LETTER BOX</u>	Select this when you connect a 4:3 screen TV. Displays a wide picture with bands on the upper and lower portions of the screen.
4:3 PAN SCAN	Select this when you connect a 4:3 screen TV. Automatically displays the wide picture on the entire screen and cuts off the portions that do not fit.
16:9	Select this when you connect a wide-screen TV or a TV with a wide mode function.

4:3 LETTER BOX



4:3 PAN SCAN

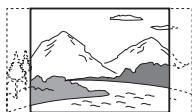

16:9

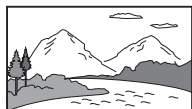

Note

Depending on the DVD, "4:3 LETTER BOX" may be selected automatically instead of "4:3 PAN SCAN" or vice versa.

◆ SCREEN SAVER

The screen saver image appears when you leave the player in pause or stop mode for 15 minutes, or when you play back a CD or DATA CD (MP3 audio) for more than 15 minutes. The screen saver will help prevent your display device from becoming damaged (ghosting). Press \triangleright to turn off the screen saver.

<u>ON</u>	Turns on the screen saver.
OFF	Turns off the screen saver.

◆ BACKGROUND

Selects the background color or picture on the TV screen in stop mode or while playing a CD or DATA CD (MP3 audio).

<u>JACKET PICTURE</u>	The jacket picture (still picture) appears, but only when the jacket picture is already recorded on the disc (CD-EXTRA, etc.). If the disc does not contain a jacket picture, the "GRAPHICS" picture appears.
GRAPHICS	A preset picture stored in the player appears.
BLUE	The background color is blue.
BLACK	The background color is black.

◆ COMPONENT OUT

This will change the type of signal output from the COMPONENT VIDEO OUT jacks on the player. See page 79 for more information about the different types.

<u>INTERLACE</u>	Select this when you are connected to a standard (interlace format) TV.
PROGRESSIVE	Select this when you have a TV that can accept progressive signals.

💡 Hint

When the player outputs progressive signals, the PROGRESSIVE indicator lights up.

Note

If you select "PROGRESSIVE" when you connect the player to a TV that cannot accept the signal in progressive format (480p), the image quality will deteriorate. In this case, set the COMPONENT VIDEO OUT/SCAN SELECT switch on the back panel of the player to INTERLACE. When you can see the TV screen correctly, set "COMPONENT OUT" to "INTERLACE" and reset the COMPONENT VIDEO OUT/SCAN SELECT switch to SELECTABLE.

Note

When you play video based software with progressive signals, sections of some types of images may appear unnatural due to the conversion process when output through the COMPONENT VIDEO OUT jacks. Images from the S VIDEO OUT 1/2 and LINE OUT VIDEO 1/2 jacks are unaffected as they are output in the interlace format.

When "PROGRESSIVE" is selected in "COMPONENT OUT"

You can fine-tune the Progressive (480p) video signal output when you select "PROGRESSIVE" in "COMPONENT OUT" of the "SCREEN SETUP" display and connect the player to the TV that is able to accept the video signal in progressive format (480p).

◆ MODE (Conversion Modes)

DVD software can be divided into two types: film based software and video based software. Video based software is derived from TV, such as dramas and sit-coms, and displays images at 30 frames/60 fields per second. Film based software is derived from film and displays images at 24 frames per second. Some DVD software contains both Video and Film.

In order for these images to appear natural on your screen when output in PROGRESSIVE mode (60 frames per second), the progressive video signal needs to be converted to match the type of DVD software that you are watching.

<u>AUTO</u>	This will automatically detect if you are playing Film based or Video based software and convert the signal to the appropriate conversion mode. Normally select this position.
VIDEO	This will set the conversion mode for Video based software, regardless of the type of software that you are playing.

Custom Settings (CUSTOM SETUP)

Use this to set up playback related and other settings.

Select "CUSTOM SETUP" in the Setup Display. To use the display, see "Using the Setup Display" (page 67).

The default settings are underlined.

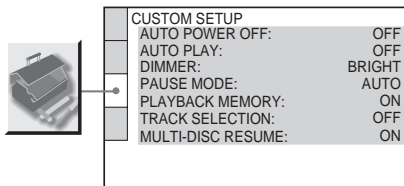

◆ AUTO POWER OFF

Switches the Auto Power Off setting on or off.

<u>OFF</u>	Switches this function off.
ON	The player enters standby mode when left in stop mode for more than 30 minutes.

◆ AUTO PLAY

Switches the Auto Play setting on or off. This function is useful when the player is connected to a timer (not supplied).

<u>OFF</u>	Switches this function off.
ON	Automatically starts playback when the player is turned on.

◆ DIMMER

Adjusts the lighting of the front panel display.

<u>BRIGHT</u>	Makes the lighting bright.
DARK	Makes the lighting dark.
OFF	Turns off the lighting.

◆ PAUSE MODE (DVD VIDEO/DVD-RW only)

Selects the picture in pause mode.

<u>AUTO</u>	The picture, including subjects that move dynamically, is output with no jitter. Normally select this position.
FRAME	The picture, including subjects that do not move dynamically, is output in high resolution.

◆ PLAYBACK MEMORY (DVD VIDEO/VIDEO CD only)

The player can store the "SUBTITLE" and other settings of each disc for up to 40 discs (Playback Memory).

Set this function "ON" or "OFF."

<u>ON</u>	Stores the settings in memory when you eject the disc.
OFF	Does not store the settings in memory.

The following settings are stored in memory.

- ANGLE (page 54)*
 - AUDIO (page 51)*
 - BNR (page 56)
 - DIGITAL VIDEO ENHANCER (page 58)
 - SUBTITLE (page 55)*
 - CUSTOM PICTURE MODE (page 57)
- * DVD VIDEO only

Notes

- The player can store the settings of up to 40 discs. When you store the setting of disc number 41, the first disc setting is canceled.
- The Playback Memory function cannot be used for DVD-RWs in VR mode.

◆ TRACK SELECTION (DVD VIDEO only)

Gives the sound track which contains the highest number of channels priority when you play a DVD VIDEO on which multiple audio formats (PCM, DTS, or Dolby Digital format) are recorded.

<u>OFF</u>	No priority given.
AUTO	Priority given.

Notes

- When you set the item to "AUTO," the language may change. The "TRACK SELECTION" setting has higher priority than the "AUDIO" settings in "LANGUAGE SETUP" (page 68).
- If you set "DTS" to "OFF" (page 73), the DTS sound track is not played even if you set "TRACK SELECTION" to "AUTO."
- If PCM, DTS, and Dolby Digital sound tracks have the same number of channels, the player selects PCM, DTS, and Dolby Digital sound tracks in this order.

◆ MULTI-DISC RESUME (DVD VIDEO/VIDEO CD only)

Switches the Multi-disc Resume setting on or off. Resume playback point can be stored in memory for up to 40 different DVD VIDEO/VIDEO CD discs (page 32).

<u>ON</u>	Stores the resume settings in memory for up to 40 discs (The settings remain in memory even if you select "OFF.")
OFF	Does not store the resume settings in memory. Playback restarts at the resume point only for the current disc in the player.

Settings for the Sound (AUDIO SETUP)

"AUDIO SETUP" allows you to set the sound according to the playback and connection conditions.

Select "AUDIO SETUP" in the Setup Display. To use the display, see "Using the Setup Display" (page 67).
The default settings are underlined.

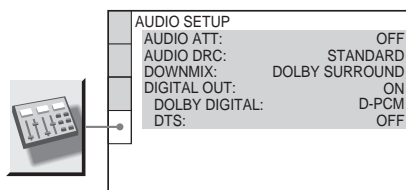

◆ AUDIO ATT (attenuation)

If the playback sound is distorted, set this item to "ON." The player reduces the audio output level.

This function affects the output of the LINE OUT L/R (AUDIO) 1/2 jacks.

<u>OFF</u>	Normally, select this position.
ON	Select this when the playback sound from the speakers is distorted.

◆ AUDIO DRC (Dynamic Range Control) (DVD VIDEO/DVD-RW only)

Makes the sound clear when the volume is turned down when playing a DVD that conforms to "AUDIO DRC." This affects the output from the following jacks:

- LINE OUT L/R (AUDIO) 1/2 jacks
- DIGITAL OUT (COAXIAL or OPTICAL) jack only when "DOLBY DIGITAL" is set to "D-PCM" (page 73).

<u>STANDARD</u>	Normally select this position.
TV MODE	Makes the low sounds clear even if you turn the volume down.
WIDE RANGE	Gives you the feeling of being at a live performance.

◆ DOWNMIX (DVD only)

Switches the method for mixing down to 2 channels when you play a DVD which has rear sound elements (channels) or is recorded in Dolby Digital format. For details on the rear signal components, see “Displaying the audio information of the disc” (page 51). This function affects the output of the following jacks:

- LINE OUT L/R (AUDIO) 1/2 jacks
- DIGITAL OUT (COAXIAL or OPTICAL) jack when “DOLBY DIGITAL” is set to “D-PCM” (page 73).

DOLBY SURROUND	Select this when the player is connected to an audio component that conforms to Dolby Surround (Pro Logic).
NORMAL	Select this when the player is connected to an audio component that does not conform to Dolby Surround (Pro Logic).

◆ DIGITAL OUT

Selects if audio signals are output via the DIGITAL OUT (COAXIAL or OPTICAL) jack.

ON	Normally select this position. When you select “ON,” see “Setting the digital output signal” for further settings.
OFF	The influence of the digital circuit upon the analog circuit is minimal.

Setting the digital output signal

Switches the method of outputting audio signals when you connect a component such as an amplifier (receiver) or MD deck with a digital input jack.

For connection details, see page 20.

Select “DOLBY DIGITAL” and “DTS” after setting “DIGITAL OUT” to “ON.”

AUDIO SETUP	
AUDIO ATT:	OFF
AUDIO DRC:	STANDARD
DOWNMIX:	DOLBY SURROUND
DIGITAL OUT:	ON
DOLBY DIGITAL:	D-PCM
DTS:	OFF

If you connect a component that does not conform to the selected audio signal, a loud noise (or no sound) will come out from the speakers, affecting your ears or causing the speakers to be damaged.

◆ DOLBY DIGITAL (DVD VIDEO/DVD-RW only)

Selects the type of Dolby Digital signal.

D-PCM	Select this when the player is connected to an audio component lacking a built-in Dolby Digital decoder. You can select whether the signals conform to Dolby Surround (Pro Logic) or not by making adjustments to the “DOWNMIX” item in “AUDIO SETUP” (page 73).
DOLBY DIGITAL	Select this when the player is connected to an audio component with a built-in Dolby Digital decoder.

◆ DTS (DVD VIDEO only)

Selects whether or not to output DTS signal.

OFF	Select this when the player is connected to an audio component lacking a built-in DTS decoder.
ON	Select this when the player is connected to an audio component with a built-in DTS decoder.

Note

If you select one of the TVS settings while playing a DVD VIDEO, the player does not output Dolby Digital signals from the DIGITAL OUT (COAXIAL or OPTICAL) jack when you set "DOLBY DIGITAL" in "AUDIO SETUP" to "D-PCM" (page 73).

Troubleshooting

If you experience any of the following difficulties while using the player, use this troubleshooting guide to help remedy the problem before requesting repairs. Should any problem persist, consult your nearest Sony dealer.

Power

The power is not turned on.

- ➔ Check that the AC power cord is connected securely.

Picture

There is no picture/picture noise appears.

- ➔ Re-connect the connecting cord securely.
- ➔ The connecting cord is damaged.
- ➔ Check the connection to your TV (page 18) and switch the input selector on your TV so that the signal from the player appears on the TV screen.
- ➔ The disc is dirty or flawed.
- ➔ If the picture output from your player goes through your VCR to get to your TV or if you are connected to a combination TV/VIDEO player, the copy-protection signal applied to some DVD programs could affect picture quality. If you still experience problems even when you connect your player directly to your TV, please try connecting your player to your TV's S VIDEO input (page 18).
- ➔ You have selected "PROGRESSIVE" in "COMPONENT OUT" even though your TV cannot accept the signal in progressive format. In this case, set the COMPONENT VIDEO OUT/SCAN SELECT switch on the back panel of the player to INTERLACE. When you can see the TV screen correctly, set "COMPONENT OUT" to "INTERLACE" and reset the COMPONENT VIDEO OUT/SCAN SELECT switch to SELECTABLE.

- ➔ Even if your TV is compatible with progressive format (480p) signals, the image may be affected when you set "COMPONENT OUT" to "PROGRESSIVE." In this case, set "COMPONENT OUT" to "INTERLACE."

Even though you set the aspect ratio in "TV TYPE" of "SCREEN SETUP," the picture does not fill the screen.

- ➔ The aspect ratio of the disc is fixed on your DVD.

Sound

There is no sound.

- ➔ Re-connect the connecting cord securely.
- ➔ The connecting cord is damaged.
- ➔ The player is connected to the wrong input jack on the amplifier (receiver) (page 22, 23, 24).
- ➔ The amplifier (receiver) input is not correctly set.
- ➔ The player is in pause mode or in Slow-motion Play mode.
- ➔ The player is in fast forward or fast reverse mode.
- ➔ If the audio signal does not come through the DIGITAL OUT (COAXIAL or OPTICAL) jack, check the audio settings (page 73).

Sound is noisy.

- ➔ When playing a CD with DTS sound tracks, noise will come from the LINE OUT L/R (AUDIO) 1/2 jacks or DIGITAL OUT (COAXIAL or OPTICAL) jack (page 28).

Sound distortion occurs.

- ➔ Set "AUDIO ATT" in "AUDIO SETUP" to "ON" (page 72).

The sound volume is low.

- ➔ The sound volume is low on some DVDs. The sound volume may improve if you set "AUDIO DRC" to "TV MODE" (page 72) and set "DOWNMIX" to "NORMAL" (page 73).
- ➔ Set "AUDIO ATT" in "AUDIO SETUP" to "OFF" (page 72).

Operation

The remote does not function.

- ➔ There are obstacles between the remote and the player.
- ➔ The distance between the remote and the player is too far.
- ➔ The remote is not pointed at the remote sensor on the player.
- ➔ The batteries in the remote are weak.

The disc does not play.

- ➔ The disc is turned over.
Insert the disc with the playback side facing down on the disc tray.
- ➔ The disc is skewed.
- ➔ The player cannot play certain discs (page 6).
- ➔ The region code on the DVD does not match the player.
- ➔ Moisture has condensed inside the player (page 3).
- ➔ The player cannot play CD-Rs, CD-RWs, DVD-Rs, or DVD-RWs (video mode) that are not finalized (page 7).

The MP3 audio track cannot be played (page 36).

- ➔ The DATA CD is not recorded in the MP3 format that conforms to ISO9660 Level 1/Level 2 or Joliet.
- ➔ The MP3 audio track does not have the extension “.MP3.”
- ➔ The data is not formatted in MP3 even though it has the extension “.MP3.”
- ➔ The data is not MPEG1 Audio Layer 3 data.
- ➔ The player cannot play audio tracks in MP3PRO format.

“Copyright lock” appears and the screen turns blue when playing a DVD-RW disc.

- ➔ Images taken from digital broadcasts, etc., may contain copy protection signals, such as complete copy protection signals, single copy signals, and restriction-free signals. When images that contain copy protection signals are played, a blue screen may appear instead of the images. It may take a while when looking for playable images.

The title of the MP3 audio album or track is not correctly displayed.

- ➔ The player can only display numbers and alphabet. Other characters are displayed as “*.”

The disc does not start playing from the beginning.

- ➔ Program Play, Shuffle Play, Repeat Play, or A-B Repeat Play has been selected (page 38).
- ➔ Resume play has taken effect (page 32).

The player starts playing the disc automatically.

- ➔ The disc features an auto playback function.
- ➔ “AUTO PLAY” in “CUSTOM SETUP” is set to “ON” (page 71).

Playback stops automatically.

- ➔ While playing discs with an auto pause signal, the player stops playback at the auto pause signal.

You cannot perform some functions such as Stop, Search, Slow-motion Play, Repeat Play, Shuffle Play, or Program Play.

- ➔ Depending on the disc, you may not be able to do some of the operations above. See the operating manual that comes with the disc.

The language for the sound track cannot be changed.

- ➔ Try using the DVD’s menu instead of the direct selection button on the remote (page 33).
- ➔ Multilingual tracks are not recorded on the DVD being played.
- ➔ The DVD prohibits the changing of the language for the sound track.

The subtitle language cannot be changed or turned off.

- ➔ Try using the DVD’s menu instead of the direct selection button on the remote (page 33).
- ➔ Multilingual subtitles are not recorded on the DVD being played.
- ➔ The DVD prohibits the changing of the subtitles.

The angles cannot be changed.

- ➔ Try using the DVD’s menu instead of the direct selection button on the remote (page 33).
- ➔ Multi-angles are not recorded on the DVD being played.

- ➔ The angle can only be changed when the "ANGLE" indicator lights up on the front panel display (page 9).
- ➔ The DVD prohibits changing of the angles.

The player does not operate properly.

- ➔ When static electricity, etc., causes the player to operate abnormally, unplug the player.

Nothing is displayed on the front panel display.

- ➔ "DIMMER" in "CUSTOM SETUP" is set to "OFF." Set "DIMMER" to "BRIGHT" or "DARK" (page 71).

5 numbers or letters are displayed on the screen and on the front panel display.

- ➔ The self-diagnosis function was activated. (See the table on page 77.)

The disc tray does not open and "LOCKED" appears on the front panel display.

- ➔ Child Lock is set (page 30).

The disc tray does not open and "TRAY LOCKED" appears on the front panel display.

- ➔ Contact your Sony dealer or local authorized Sony service facility.

"Data error" appears on the TV screen when playing a DATA CD.

- ➔ The MP3 audio track you want to play is broken.
- ➔ The data is not MPEG1 Audio Layer 3 data.

Self-diagnosis Function

(When letters/numbers appear in the display)

When the self-diagnosis function is activated to prevent the player from malfunctioning, a five-character service number (e.g., C 13 50) with a combination of a letter and four digits appears on the screen and the front panel display. In this case, check the following table.

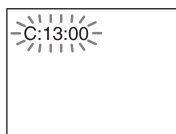

First three characters of the service number	Cause and/or corrective action
C 13	The disc is dirty. ➔ Clean the disc with a soft cloth (page 7).
C 31	The disc is not inserted correctly. ➔ Re-insert the disc correctly.
E XX (xx is a number)	To prevent a malfunction, the player has performed the self-diagnosis function. ➔ Contact your nearest Sony dealer or local authorized Sony service facility and give the 5-character service number. Example: E 61 10

Glossary

Chapter (page 9)

Sections of a picture or a music feature that are smaller than titles. A title is composed of several chapters. Depending on the disc, no chapters may be recorded.

Dolby Digital (page 24, 73)

Digital audio compression technology developed by Dolby Laboratories. This technology conforms to 5.1-channel surround sound. The rear channel is stereo and there is a discrete subwoofer channel in this format. Dolby Digital provides the same 5.1 discrete channels of high quality digital audio found in Dolby Digital cinema audio systems. Good channel separation is realized because all of the channel data are recorded discretely and little deterioration is realized because all channel data processing is digital.

Dolby Surround (Pro Logic) (page 23)

Audio signal processing technology that Dolby Laboratories developed for surround sound. When the input signal contains a surround component, the Pro Logic process outputs the front, center and rear signals. The rear channel is monaural.

DTS (page 24, 73)

Digital audio compression technology that Digital Theater Systems, Inc. developed. This technology conforms to 5.1-channel surround sound. The rear channel is stereo and there is a discrete subwoofer channel in this format. DTS provides the same 5.1 discrete channels of high quality digital audio. Good channel separation is realized because all of the channel data is recorded discretely and little deterioration is realized because all channel data processing is digital.

DVD VIDEO (page 6)

A disc that contains up to 8 hours of moving pictures even though its diameter is the same as a CD.

The data capacity of a single-layer and single-sided DVD is 4.7 GB (Giga Byte), which is 7 times that of a CD. The data capacity of a double-layer and single-sided DVD is 8.5 GB, a single-layer and double-sided DVD is 9.4 GB, and double-layer and double-sided DVD is 17 GB.

The picture data uses the MPEG 2 format, one of the worldwide standards of digital compression technology. The picture data is compressed to about 1/40 (average) of its original size. The DVD also uses a variable rate coding technology that changes the data to be allocated according to the status of the picture. Audio information is recorded in a multi-channel format, such as Dolby Digital, allowing you to enjoy a more real audio presence.

Furthermore, various advanced functions such as the multi-angle, multilingual, and Parental Control functions are provided with the DVD.

DVD-RW (page 6)

A DVD-RW is a recordable and rewritable disc with the same size as the DVD VIDEO. The DVD-RW can be recorded in two different modes: VR mode and Video mode. VR (Video Recording) mode enables various programming and editing functions, some of which are limited in the case of Video mode. Video mode complies with DVD VIDEO format and can be played on other DVD players while a DVD-RW recorded in VR mode can only be played on DVD-RW compliant players. The "DVD-RW" appearing in this manual, and the on-screen displays refer to DVD-RWs in VR mode.

Film based software, Video based software (page 70)

DVDs can be classified as Film based or Video based software. Film based DVDs contain the same images (24 frames per second) that are shown at movie theaters. Video based DVDs, such as television dramas or sit-coms, displays images at 30 frames (or 60 fields) per second.

Interlace format (page 69)

Interlace format shows every other line of an image as a single “field” and is the standard method for displaying images on television. The even number field shows the even numbered lines of an image, and the odd numbered field shows the odd numbered lines of an image.

Index (CD)/Video Index (VIDEO CD) (page 9)

A number that divides a track into sections to easily locate the point you want on a CD or VIDEO CD. Depending on the disc, no index may be recorded.

Progressive format (page 69)

Compared to the Interlace format that alternately shows every other line of an image (field) to create one frame, the Progressive format shows the entire image at once as a single frame. This means that while the Interlace format can show 30 frames (60 fields) in one second, the Progressive format can show 60 frames in one second. The overall picture quality increases and still images, text, and horizontal lines appear sharper. This player is compatible with the 480 progressive format.

Scene (page 9)

On a VIDEO CD with PBC (playback control) functions, the menu screens, moving pictures and still pictures are divided into sections called “scenes.”

Title (page 9)

The longest section of a picture or music feature on a DVD, movie, etc., in video software, or the entire album in audio software.

Track (page 9)

Sections of a picture or a music feature on a CD or VIDEO CD (the length of a song).

Specifications

System

Laser: Semiconductor laser

Signal format system: NTSC

Audio characteristics

Frequency response: DVD VIDEO (PCM 96 kHz): 2 Hz to 44 kHz (± 1.0 dB)/DVD VIDEO (PCM 48 kHz): 2 Hz to 22 kHz (± 0.5 dB)/CD: 2 Hz to 20 kHz (± 0.5 dB)

Signal-to-noise ratio (S/N ratio): 115 dB (LINE OUT L/R (AUDIO) 1/2 jacks only)

Harmonic distortion: 0.003 %

Dynamic range: DVD VIDEO: 103 dB/CD: 99 dB

Wow and flutter: Less than detected value ($\pm 0.001\%$ W PEAK)

The signals from LINE OUT L/R (AUDIO) 1/2 jacks are measured. When you play PCM sound tracks with a 96 kHz sampling frequency, the output signals from the DIGITAL OUT (COAXIAL or OPTICAL) jack are converted to 48 kHz sampling frequency.

Outputs

(Jack name: Jack type/Output level/Load impedance)

LINE OUT L/R (AUDIO) 1/2: Phono jack/
2 Vrms/10 kilohms

DIGITAL OUT (OPTICAL): Optical
output jack/-18 dBm (wave length:
660 nm)

DIGITAL OUT (COAXIAL): Phono jack/
0.5 Vp-p/75 ohms

COMPONENT VIDEO OUT (Y, P_B, P_R):
Phono jack/Y: 1.0 Vp-p/P_B, P_R:
0.7 Vp-p/75 ohms

LINE OUT (VIDEO) 1/2: Phono jack/
1.0 Vp-p/75 ohms

S VIDEO OUT 1/2: 4-pin mini DIN/
Y: 1.0 Vp-p/C: 0.286 Vp-p/75 ohms

General

Power requirements:

120 V AC, 60 Hz

Power consumption: 17 W

Dimensions (approx.): 430 × 108 × 413 mm
(17 × 4 ³/₈ × 16 ³/₈ in.) (width/height/
depth) incl. projecting parts

Mass (approx.): 5.1 kg (11 lb 4 oz)

Operating temperature: 5 °C to 35 °C
(41 °F to 95 °F)

Operating humidity: 25 % to 80 %

Supplied accessories

See page 15.

Specifications and design are subject to change without notice.

ENERGY STAR® is a U.S. registered mark. As an ENERGY STAR® Partner, Sony Corporation has determined that this product meets the ENERGY STAR® guidelines for energy efficiency.

Language Code List

For details, see pages 51, 55, 68.

The language spellings conform to the ISO 639: 1988 (E/F) standard.

Code	Language	Code	Language	Code	Language	Code	Language
1027	Afar	1183	Irish	1347	Maori	1507	Samoa
1028	Abkhazian	1186	Scots Gaelic	1349	Macedonian	1508	Shona
1032	Afrikaans	1194	Galician	1350	Malayalam	1509	Somali
1039	Amharic	1196	Guarani	1352	Mongolian	1511	Albanian
1044	Arabic	1203	Gujarati	1353	Moldavian	1512	Serbian
1045	Assamese	1209	Hausa	1356	Marathi	1513	Siswati
1051	Aymara	1217	Hindi	1357	Malay	1514	Sesotho
1052	Azerbaijani	1226	Croatian	1358	Maltese	1515	Sundanese
1053	Bashkir	1229	Hungarian	1363	Burmese	1516	Swedish
1057	Byelorussian	1233	Armenian	1365	Nauru	1517	Swahili
1059	Bulgarian	1235	Interlingua	1369	Nepali	1521	Tamil
1060	Bihari	1239	Interlingue	1376	Dutch	1525	Telugu
1061	Bislama	1245	Inupiak	1379	Norwegian	1527	Tajik
1066	Bengali; Bangla	1248	Indonesian	1393	Occitan	1528	Thai
1067	Tibetan	1253	Icelandic	1403	(Afan)Oromo	1529	Tigrinya
1070	Breton	1254	Italian	1408	Oriya	1531	Turkmen
1079	Catalan	1257	Hebrew	1417	Punjabi	1532	Tagalog
1093	Corsican	1261	Japanese	1428	Polish	1534	Setswana
1097	Czech	1269	Yiddish	1435	Pashto; Pushto	1535	Tonga
1103	Welsh	1283	Javanese	1436	Portuguese	1538	Turkish
1105	Danish	1287	Georgian	1463	Quechua	1539	Tsonga
1109	German	1297	Kazakh	1481	Rhaeto- Romance	1540	Tatar
1130	Bhutani	1298	Greenlandic	1482	Kirundi	1543	Twi
1142	Greek	1299	Cambodian	1483	Romanian	1557	Ukrainian
1144	English	1300	Kannada	1489	Russian	1564	Urdu
1145	Esperanto	1301	Korean	1491	Kinyarwanda	1572	Uzbek
1149	Spanish	1305	Kashmiri	1495	Sanskrit	1581	Vietnamese
1150	Estonian	1307	Kurdish	1498	Sindhi	1587	Volapük
1151	Basque	1311	Kirghiz	1501	Sangho	1613	Wolof
1157	Persian	1313	Latin	1502	Serbo- Croatian	1632	Xhosa
1165	Finnish	1326	Lingala	1503	Singhalese	1665	Yoruba
1166	Fiji	1327	Laothian	1505	Slovak	1684	Chinese
1171	Faroese	1332	Lithuanian	1506	Slovenian	1697	Zulu
1174	French	1334	Latvian; Lettish				
1181	Frisian	1345	Malagasy			1703	Not specified

Index

Numerics

- 16:9 69
- 4:3 LETTER BOX 69
- 4:3 PAN SCAN 69
- 5.1 Channel Surround 20

A

- A-B REPEAT 42
- ADVANCED 49
- ALBUM 44
- Album 36
- ALL DISCS/ONE DISC 38
- ANGLE 54
- ANGLE VIEWER 45
- AUDIO 51, 68
- AUDIO ATT 72
- AUDIO DRC 72
- AUDIO SETUP 72
- AUTO 70
- AUTO PLAY 71
- AUTO POWER OFF 71

B

- BACKGROUND 69
- Batteries 15
- BNR 56

C

- CD 28
- CHAPTER 44
- Chapter 9, 78
- CHAPTER VIEWER 45
- Checking a disc loaded 29
- Child Lock 30
- COMPONENT OUT 69
- Connecting 18
- Continuous play
 - CD/VIDEO CD 28
 - DATA CD 35
 - DVD 28
- Control Menu 12
- CUSTOM 67
- CUSTOM PARENTAL CONTROL 60
- CUSTOM PICTURE MODE 57
- CUSTOM SETUP 71

D

- DATA CD 6, 35
- DIGITAL OUT 73
- Digital output 73
- DIGITAL VIDEO ENHANCER 58
- DIMMER 71
- Display

- Control Bar display 12
- Front panel display 9, 48
- Setup Display 67

- DOLBY DIGITAL 23, 24, 51, 73, 78
- DOWNMIX 73
- DTS 24, 51, 73, 78
- DVD VIDEO 6, 28, 78
- DVD/CD text 47
- DVD-RW 6, 33, 78

F

- Fast forward 31
- Fast reverse 31
- Front panel display 9, 48

H

- Handling discs 7
- Hooking up 18

I

- INDEX 44
- Index 79
- INTERLACE 69, 79

L

- LANGUAGE SETUP 68
- Locating
 - a specific point by watching the TV screen 31

M

- MENU 68
- Menu
 - DVD's menu 33
 - Top menu 33
- MODE 70
- MP3 6, 35
- MULTI-DISC RESUME 32, 72

O

- On-screen display
 - Setup Display 67
- ORIGINAL 33
- ORIGINAL/PLAY LIST 33
- OSD 68

P

- PARENTAL CONTROL 60
- PAUSE MODE 71
- PBC Playback 34
- PICTURE NAVIGATION 45
- PLAY LIST 33
- PLAYBACK MEMORY 71
- PRO LOGIC 23, 78

- PROGRAM 38
- Program Play 38
- PROGRESSIVE 69, 79

Q

- QUICK 68
- Quick Setup 25, 68

R

- Remote 15, 65
- REPEAT 41
- Repeat Play 41
- Replacing discs while playing a disc 30
- REPLAY 29
- Resume Play 32

S

- S VIDEO output 18
- SCENE 44
- Scene 9, 79
- SCREEN SAVER 69
- SCREEN SETUP 69
- Searching 31
- Selecting a disc 29
- SETUP 67
- Setup Display 67
- SHUFFLE 40
- Shuffle Play 40
- Skipping a disc 28
- Slow-motion Play 31
- Speakers
 - Hooking up 20
- STROBE PLAYBACK 45
- SUBTITLE 55, 68
- SURROUND 52

T

- TIME/TEXT 44, 47
- TITLE 44
- Title 9, 79
- TITLE VIEWER 45
- TOP MENU 33
- TRACK 44
- Track 9, 36, 79
- TRACK SELECTION 71
- TRACK VIEWER 45
- Troubleshooting 75
- TV TYPE 69
- TVS (TV Virtual Surround) 52

U

- Usable discs 6

V

- VIDEO 70

